



NELSON EXHAUST (QLD) PTY LTD

*Serving the Transport, Construction,
Mining, Marine & Agricultural
Industries*

Product Catalogue

**Retail & Wholesale
FOR ALL YOUR DIESEL EXHAUST
COMPONENTS**



Ph

07 3274 2666

Fax

07 3275 2836

Email

sales@nelsonexhaust.com.au

parts@nelsonexhaust.com.au

Web

www.nelsonexhaust.com.au

Unit 5 / 1909 Ipswich Rd, Rocklea Qld 4106
(entrance via Collinsvale Street)

*Proudly an Australian owned company, designing and producing
acoustical products for the diesel powered industry.*

Nelson Exhaust (Qld) Pty Ltd was established in Brisbane, Queensland in February 1985. The company's directive is to serve the diesel industry with a complete and extensive range of exhaust equipment.



Nelson Exhaust has an extensive range of Nelson Global Products, Tieceo & Donaldson products with over 2500 exhaust and air intake parts.

To cater for the diesel industry a huge array of stock items consisting of v-band clamps adaptors, bends, mufflers, flexible tubing, chrome stacks, tubular fittings, heat shields and tubing from 25mm (1") to 254mm (10") are available over the counter.

These products can be used widely in the diesel industry including on-highway heavy and medium duty trucks, stationary power units, industrial equipment, construction, mining, agricultural and marine.

AFTERMARKET PRODUCTS

After market mufflers are manufactured in our Rocklea factory to suit all types of transport, earthmoving, agricultural, mining and construction equipment. Caterpillar, Komatsu, Hitachi, Volvo, International and many more are all catered for.

Also manufactured at the Rocklea plant is a complete catalogue range of Industrial, Residential and Critical silencers for Gensets, Pumpsets and Marine applications where noise emission restraints are necessary. Other items utilized in this zone are vibration/expansion joints and catalytic purifiers.

DESIGN & MANUFACTURING

Our staff have over 35 years experience and over these years have established a unique partnership with our customers and suppliers. The professionalism and technical knowledge our staff bring to every product we produce is only matched by our dedication and commitment ensuring that our customer's needs are met.



index

Adaptors	Page 42 - 43
Air Compressors & Air Tank Kits	Page 30
Air Intake	Page 80 - 85
Air Ram	Page 81
Aluminium Tape	Page 28
Brackets	Page 68 - 71
Bends - 30°, 45°, 60°, 90° & 180°	Page 20 - 25
Cable Ties - Stainless Steel	Page 28
Clamps	Page 31 - 37
Clamp Kits	Page 74
Cones	Page 41
Connectors	Page 67
Cotton Reel Mount	Page 69
Couplers	Page 38 - 39
Design & Manufacture	Page 4
Donuts	Page 45
Exhaust Cement	Page 28
Exhaust Gas Purifiers	Page 6 - 7
Exhaust Lagging	Page 28
Flame Proof Tanker Kits	Page 46 - 49
Flanges	Page 86
Flex (Bellows) connectors	Page 29
Gaskets	Page 87
Guards	Page 72 - 73
Handles (Grab)	Page 33
Hangers	Page 66
Kenworth Products	Page 30
Lipped Flange	Page 40 - 41
Metal Polish	Page 28
Mufflers	Page 50 - 64
Mufflers - Performance	Page 65
Mufflers - Sports	Page 65
Parrop (corrugated tube)	Page 19
Pre Cleaners	Page 78 - 79
Rain Caps	Page 18 - 19
Repairs	Page 5
Rubber Mount	Page 69
Spark Arrestors	Page 75 - 77
Stacks	Page 8 - 17
Thermo Blankets	Page 19
Tube	Page 26 - 27
Y Junctions	Page 43 - 44

design & manufacture

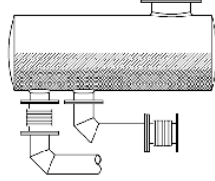
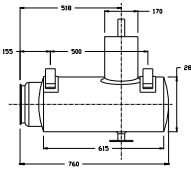

We have on file an extensive range of after market mufflers to suit every type of plant equipment or machine.

We specialize in custom size adapters or staff can manufacture to your specific requirements.

Industrial, Residential and Critical Residential silences for Gensets, Pumpsets and Marine applications are all designed & manufactured at our Rocklea factory.

A complete range of Silencers can be viewed on our web site www.nelsonexhaust.com.au then click on the Exhaust-a-Logue tab then click on Silencers tab.



repairs to muffler & tube work

Bring in your damaged parts (muffler and/or tube work) for repair or replacement.

Our experienced workshop staff are capable of doing small or large repairs but it must be off the vehicle.

MIG & TIG welding available

Mild Steel, Aluminized,
Aluminium & Stainless Steel

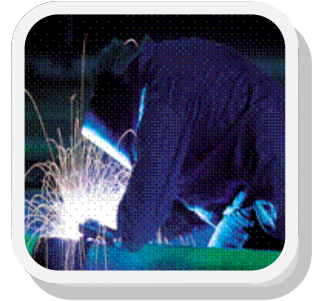

EXHAUST GAS PURIFIERS

Exhaust gas purifiers lower carbon monoxide hydrocarbons and other odors in engine exhaust emissions by up to 90%.

This translates to less eye irritation & diesel odour is virtually eliminated. Improves air quality and working conditions for your staff.

- Underground mining
- Generating sets
- Stationary engines
- Trucks
- Buses
- Pumps
- Compressors
- Excavation & construction machinery



The conversions take place as the exhaust gas passes through a metallic substrate coated with precious metal and is packaged into a robust stainless steel housing. Catalytic action commences when the exhaust gas temperature entering the purifier reaches approximately 200°C.

The Conversion rate is a function of temperature with maximum efficiency achieved when the engine is operating at full load.

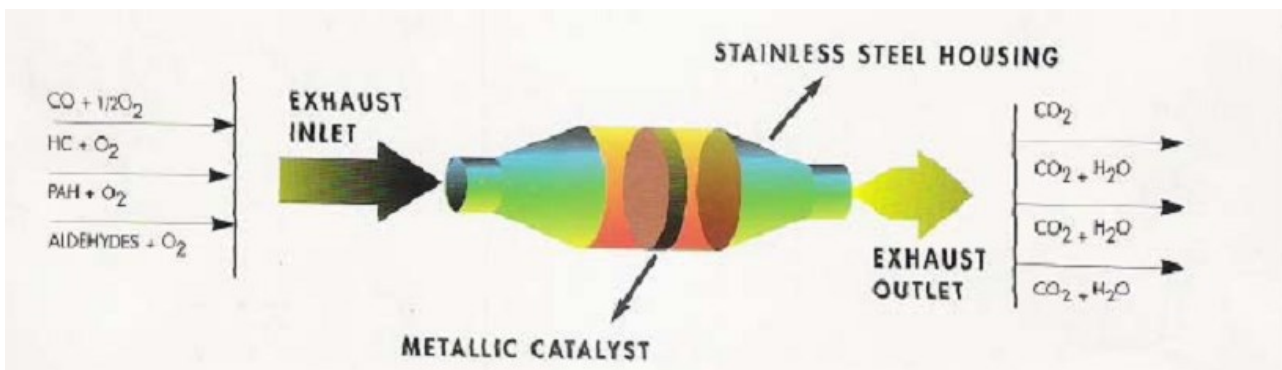

HIGH FLOW CATALYTIC CONVERTORS

DESCRIPTION	PART NO
Cat Converter 63mm-100 cells	CAT063-100
3" High Flow 100 cells CAT	CAT075
3" High Flow 200 cells CAT	CAT075-200





Nelson Exhaust (Qld) Pty Ltd
 1909 Ipswich Rd, Rocklea Qld 4106
 T 07 3274 2666 F 07 3275 2836
 E sales@nelsonexhaust.com.au

EXHAUST PURIFIER ENGINE DETAILS

COMPANY NAME _____

CONTACT PERSON _____

TELEPHONE _____ FAX _____

CUSTOMER REQUIREMENTS Purifier only Purifier/Muffler

ENGINE TYPE Diesel LPG

Dual Fuel

ENGINE DISPLACEMENT (Litres) _____

ENGINE CYCLE Four Stroke Two Stroke

ENGINE ASPIRATION Naturally Aspirated Turbo Charged

Turbo Aftercooled

MAXIMUM ENGINE RPM _____

EXHAUST PIPE OD _____

EXHAUST GAS TEMPERATURE _____

EXHAUST GAS FLOW _____

GENERAL DESCRIPTION OF ENGINE APPLICATION _____

OFFICE USE ONLY

Calculate Purifier Sizing _____

Sales Person _____ Date _____

EXHAUST STACKS—DEFLECTOR (plain end)

DIMENSIONAL	DATA	CHROME PLATED
51mm x	600mm (24")	0123D0522P
(2")	900mm (36")	0123D0523P
	1200mm (47")	0123D0524P
	1500mm (59")	0123D0525P
	1800mm (71")	0123D0526P
57mm x	600mm (24")	0123D0572P
(2¼")	900mm (36")	0123D0573P
	1200mm (47¼")	0123D0574P
	1500mm (59")	0123D0575P
	1800mm (71")	0123D0576P
63mm x	600mm (24")	0123D0632P
(2½")	900mm (36")	0123D0633P
	1200mm (47¼")	0123D0634P
	1500mm (59")	0123D0635P
	1800mm (71")	0123D0636P
70mm x	600mm (24")	0123D0702P
(2¾")	900mm (36")	0123D0703P
	1200mm (47¼")	0123D0704P
	1500mm (59")	0123D0705P
	1800mm (71")	0123D0706P
76mm x	600mm (24")	0123D0762P
(3")	900mm (36")	0123D0763P
	1200mm (47¼")	0123D0764P
	1500mm (59")	0123D0765P
	1800mm (71")	0123D0766P

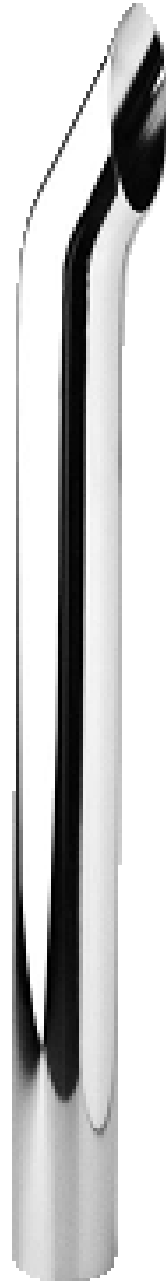

EXHAUST STACKS—DEFLECTOR (plain end)

DIMENSIONAL	DATA	CHROME PLATED
89mm x	600mm (24")	0123D0892P
	900mm (36")	0123D0893P
	1200mm (47")	0123D0894P
	1500mm (59")	0123D0895P
	1800mm (71")	0123D0896P
102mm x	600mm (24")	0123D1022P
(4")	900mm (36")	0123D1023P
	1200mm (47")	0123D1024P
	1500mm (59")	0123D1025P
	1800mm (71")	0123D1026P
114mm x	600mm (24")	0123D1142P
(4½")	900mm (36")	0123D1143P
	1200mm (47¼")	0123D1144P
	1500mm (59")	0123D1145P
	1800mm (71")	0123D1146P
127mm x	600mm (24")	0123D1272P
(5")	900mm (36")	0123D1273P
	1200mm (47¼")	0123D1274P
	1500mm (59")	0123D1275P
	1800mm (71")	0123D1276P
152mm x	600mm (24")	0123D1522P
(6")	900mm (36")	0123D1523P
	1200mm (47¼")	0123D1524P
	1500mm (59")	0123D1525P
	1800mm (71")	0123D1526P
178mm x	900mm (36")	0123D1783P
(7")	1200mm (47¼")	0123D1784P
	1500mm (59")	0123D1785P
	1800mm (71")	0123D1786P



- The use of Chrome plated stacks will enhance the outer appearance of the vehicle.
- When replacing a deflector, clamps should be inspected and replaced to ensure that the stack is in a steadfast position at all times.

EXHAUST STACKS—DEFLECTOR (expanded & notched)

DIMENSIONAL	DATA	CHROME PLATED	CHROME PLATED METRIC STACK
51mm x	600mm (24")	0123D0522X	-
(2")	900mm (36")	0123D0523X	-
	1200mm (47")	0123D0524X	-
	1500mm (59")	0123D0525X	-
	1800mm (71")	0123D0526X	-
57mm x	600mm (24")	0123D0572X	-
(2¼")	900mm (36")	0123D0573X	-
	1200mm (47¼")	0123D0574X	-
	1500mm (59")	0123D0575X	-
	1800mm (71")	0123D0576X	-
63mm x	600mm (24")	0123D0632X	-
(2½")	900mm (36")	0123D0633X	-
	1200mm (47¼")	0123D0634X	-
	1500mm (59")	0123D0635X	-
	1800mm (71")	0123D0636X	-
70mm x	600mm (24")	0123D0702X	-
(2¾")	900mm (36")	0123D0703X	-
	1200mm (47¼")	0123D0704X	-
	1500mm (59")	0123D0705X	-
	1800mm (71")	0123D0706X	-
76mm x	600mm (24")	0123D0762X	0123D0762HX
(3")	900mm (36")	0123D0763X	0123D0763HX
	1200mm (47¼")	0123D0764X	0123D0764HX
	1500mm (59")	0123D0765X	0123D0765HX
	1800mm (71")	0123D0766X	0123D0766HX



- The use of Chrome plated stacks will enhance the outer appearance of the vehicle.
- When replacing a deflector, clamps should be inspected and replaced to ensure that the stack is in a steadfast position at all times.

EXHAUST STACKS—DEFLECTOR (expanded & notched)

DIMENSIONAL	DATA	CHROME PLATED	CHROME PLATED METRIC STACK
89mm x	600mm (24")	0123D0892X	0123D0892HX
	900mm (36")	0123D0893X	0123D0893HX
	1200mm (47")	0123D0894X	0123D0894HX
	1500mm (59")	0123D0895X	0123D0895HX
	1800mm (71")	0123D0896X	0123D0896HX
102mm x	600mm (24")	0123D1022X	-
(4")	900mm (36")	0123D1023X	-
	1200mm (47")	0123D1024X	-
	1500mm (59")	0123D1025X	-
	1800mm (71")	0123D1026X	-
114mm x	600mm (24")	0123D1142X	-
(4½")	900mm (36")	0123D1143X	-
	1200mm (47¼")	0123D1144X	-
	1500mm (59")	0123D1145X	-
	1800mm (71")	0123D1146X	-
127mm x	600mm (24")	0123D1272X	-
(5")	900mm (36")	0123D1273X	-
	1200mm (47¼")	0123D1274X	-
	1500mm (59")	0123D1275X	-
	1800mm (71")	0123D1276X	-
152mm x	600mm (24")	0123D1522X	-
(6")	900mm (36")	0123D1523X	-
	1200mm (47¼")	0123D1524X	-
	1500mm (59")	0123D1525X	-
	1800mm (71")	0123D1526X	-
178mm x	900mm (36")	0123D1783X	-
(7")	1200mm (47¼")	0123D1784X	-
	1500mm (59")	0123D1785X	-
	1800mm (71")	0123D1786X	-

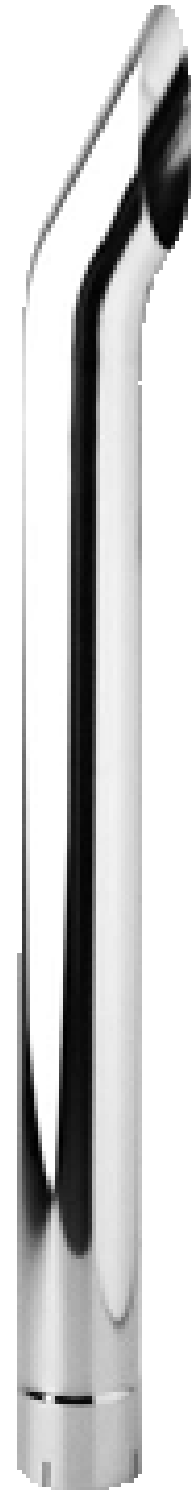

STRAIGHT STACKS—CHROME PLATED

DIMENSIONAL	DATA	PLAIN END	EXPANDED & NOTCHED
51mm x	600mm (24")	0123S0522P	0123S0522X
(2")	900mm (36")	0123S0523P	0123S0523X
	1200mm (47")	0123S0524P	0123S0524X
	1500mm (59")	0123S0525P	0123S0525X
	1800mm (71")	0123S0526P	0123S0526X
57mm x	600mm (24")	0123S0572P	0123S0572X
(2¼")	900mm (36")	0123S0573P	0123S0573X
	1200mm (47¼")	0123S0574P	0123S0574X
	1500mm (59")	0123S0575P	0123S0575X
	1800mm (71")	0123S0576P	0123S0576X
63mm x	600mm (24")	0123S0632P	0123S0632X
(2½")	900mm (36")	0123S0633P	0123S0633X
	1200mm (47¼")	0123S0634P	0123S0634X
	1500mm (59")	0123S0635P	0123S0635X
	1800mm (71")	0123S0636P	0123S0636X
70mm x	600mm (24")	0123S0702P	0123S0702X
(2¾")	900mm (36")	0123S0703P	0123S0703X
	1200mm (47¼")	0123S0704P	0123S0704X
	1500mm (59")	0123S0705P	0123S0705X
	1800mm (71")	0123S0706P	0213S076X
76mm x	600mm (24")	89005C	0123S0762X
(3")	900mm (36")	89006C	89020C
	1200mm (47¼")	89007C	89021C
	1500mm (59")	89203C	89213C
	1800mm (71")	0123S0766P	0123S0766X
89mm x	600mm (24")	89010C	89022C
(3½")	900mm (36")	89011C	89023C
	1200mm (47¼")	89012C	89024C
	1500mm (59")	89204C	89215C
	1800mm (71")	0123S0896P	0123S0896X



STRAIGHT STACKS—CHROME PLATED

DIMENSIONAL	DATA	PLAIN END	EXPANDED & NOTCHED
102mm x	600mm (24")	89013C	89025C
(4")	900mm (36")	89014C	89026C
	1200mm (47")	89015C	89027C
	1500mm (59")	89205C	89217C
	1800mm (71")	89916C	89919C
114mm x	600mm (24")	0123S1142P	0123S1142X
(4½")	900mm (36")	0123S1143P	0123S1143X
	1200mm (47¼")	0123S1144P	0123S1144X
	1500mm (59")	0123S1145P	0123S1145X
	1800mm (71")	0123S1146P	0123S1146X
127mm x	600mm (24")	89016C	89028C
(5")	900mm (36")	89017C	89029C
	1200mm (47¼")	89018C	89030C
	1500mm (59")	89019C	89031C
	1800mm (71")	89918C	89920C
152mm x	600mm (24")	0123S1522P	0123S1522X
(6")	900mm (36")	0123S1523P	0123S1523X
	1200mm (47¼")	0123S1524P	0123S1524X
	1500mm (59")	0123S1525P	0123S1525X
	1800mm (71")	0123S1526P	0123S1526X
178mm x	900mm (36")	0123S1783P	0123S1783X
(7")	1200mm (47¼")	0123S1784P	0123S1784X
	1500mm (59")	0123S1785P	0123S1785X
	1800mm (71")	0123S1786P	0123S1786X



SUPER STACKS

'Aus' Style Chrome Plated—Reduced Inlet

DIMENSIONAL	DATA	STRAIGHT PLAIN	NOTCHED
127(102) x	900mm (36")	0123S1273RP	0123S1273RX
(5(4"))	1200mm (47")	0123S1274RP	0123S1274RX
	1500mm (59")	0123S1275RP	0123S1275RX
	1800mm (71")	0123S1276RP	0123S1276RX
152(127) x	900mm (36")	0123S1523RP	0123S1523RX
(6(5"))	915mm (36")	-	-
	1200mm (47¼")	0123S152RP	0123S152RX
	1219mm (48")	-	-
	1500mm (59")	0123S1525RP	0123S1525RX
	1524mm (60")	-	-
	1800mm (71")	0123S1526RP	0123S1526RX
	1829mm (72")	-	-
	2134mm (84")	-	-
	2438mm (96")	-	-
	2743mm (108")	-	-
	3048mm (120")	-	-
178(127) x	900mm (36")	0123S1783RP	0123S1783RX
(7(5"))	1200mm (47¼")	0123S1784RP	0123S1784RX
	1500mm (59")	0123S1785RP	0123S1785RX
	1800mm (72")	0123S1786RP	0123S1786RX

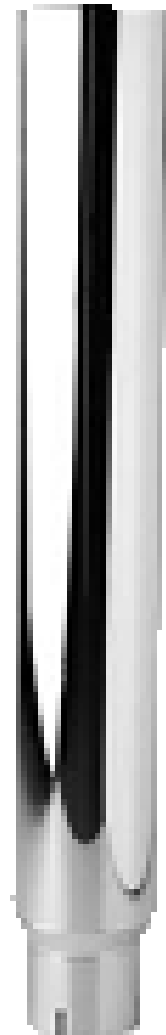

Other sizes available on request

SUPER STACKS

'Aus' Style Chrome Plated—Reduced Inlet

DIMENSIONAL	DATA	DEFLECTOR PLAIN	NOTCHED
127(102) x	900mm (36")	0123D1273RP	0123D1273RX
(5(4"))	1200mm (47")	0123D1274RP	0123D1274RX
	1500mm (59")	0123D1275RP	0123D1275RX
	1800mm (71")	0123D1276RP	0123D1276RX
152(127) x	900mm (36")	0123D1523RP	0123D1523RX
(6(5"))	915mm (36")	-	-
	1200mm (47¼")	0123D1524RP	0123D1524RX
	1219mm (48")	-	-
	1500mm (59")	0123D1525RP	0123D1525RX
	1524mm (60")	-	-
	1800mm (71")	0123D1526RP	0123D1526RX
	1829mm (72")	-	-
	2134mm (84")	-	-
	2438mm (96")	-	-
	2743mm (108")	-	-
	3048mm (120")	-	-
178(127) x	900mm (36")	0123D1783RP	0123D1783RX
(7(5"))	1200mm (47¼")	0123D1784RP	0123D1784RX
	1500mm (59")	0123D1785RP	0123D1785RX
	1800mm (72")	0123D1786RP	0123D1786RX

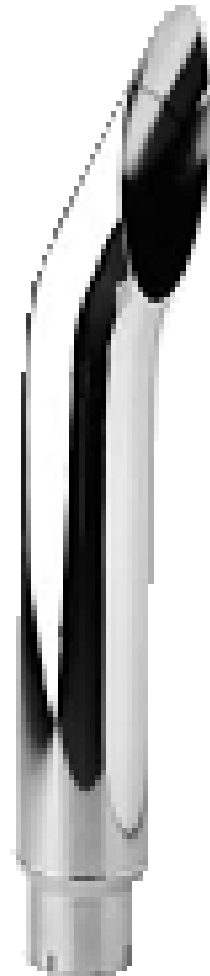

Other sizes available on request

MITRE CUT STACKS Chrome Plated 45° Straight Inlet

TUBE OD	X LENGTH	PLAIN END	NOTCHED
102 x	457mm (18")	89921C	89906C
(4")	900mm (36")	89991C	90593C
	1200mm (47")	89992C	90595C
	1500mm (59")	CPMS1025P	CPMS1025X
	1800mm (71")	CPMS 1026P	CPMS1026X
127 x	457mm (18")	89922C	89910C
(5")	900mm (36")	89993C	CPMS1273X
	1200mm (47¼")	89994C	CPMS1274X
	1500mm (59")	90438C	90439C
	1800mm (71")	90589C	90440C
	2134mm (84")	90590C	90441C
	2438mm (96")	90591C	90442C
	2743mm (108")	900036C	90597C
	3048mm (120")	900037C	90604C
152 x	900mm (36")	CPMS1523P	CPMS1523X
(6")	1200mm (47¼")	CPMS1524P	CPMS1524X
	1500mm (59")	CPMS1525P	CPMS1525X
	1800mm (71")	CPMS1526P	CPMS1526X
178 x	900mm (36")	CPMS1783P	CPMS1783X
(7")	1200mm (47¼")	CPMS1784P	CPMS1784X
	1500mm (59")	CPMS1785P	CPMS1785X
	1800mm (71")	CPMS1786P	CPMS1786X



- Mitre Cut stacks gives the impression of a quieter vehicle as the noise is directed away from the ground.
- These stacks have a angle cut of 45° at the top of the stack.
- Also known as West Coast and Angle Cut stacks.

MITRE CUT STACKS—Chrome Plated 45° Straight Inlet

TUBE OD	X LENGTH	PLAIN END	NOTCHED
127 (102) x	900mm (36")	CPMS1273RP	CPMS1273RX
	1200mm (47¼")	CPMS1274RP	CPMS1274RX
	1500mm (59")	CPMS1275RP	CPMS1275RX
	1800mm (71")	CPMS1276RP	CPMS1276RX
152 (127) x	900mm (36")	900092C	CPMS1523RX
	1200mm (47¼")	900093C	900035C
	1500mm (59")	900094C	CPMS1525RX
	1800mm (71")	CPMS1526RP	CPMS1526RX
	2438mm (96")	-	90576C
	2743mm (108")	-	90578C
	3048mm (120")	-	90577C
178 (127) x	900mm (36")	CPMS1783RP	CPMS1783RX
	1200mm (47¼")	CPMS1784RP	CPMS1784RX
	1500mm (59")	CPMS1785RP	CPMS1785RX
	1800mm (71")	CPMS1786RP	CPMS1786RX

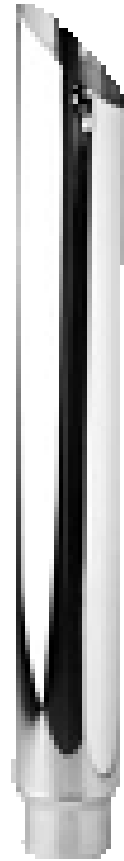

STRAIGHT STACKS

CHROME PLATED EXHAUST STACKS STRAIGHT—special length

TUBE OD	X LENGTH	PLAIN END	EXPANDED & NOTCHED
127 (102) x	1371mm (54")	90605C	90609C
(5")	1625mm (64")	90606C	-
	2134mm (84")	90607C	90610C
	2438mm (96")	90608C	90611C
	2743mm (108")	-	90612C
	3048mm (120")	-	90613C

SILENT RAINCAPS

SUIT OD	ZINC PLATED	CHROME PLATED
38mm 1½"	0171038ES	0171038ESC
44mm 1¾"	0171044ES	0171044ESC
51mm 2"	0171051ES	0171051ESC
57mm 2¼"	0171057ES	0171057ESC
63mm 2½"	0171063ES	0171063ESC
70mm 2¾"	0171070ES	-
76mm 3"	0171076ES	0171076ESC
89mm 3½"	0171089ES	0171089ESC
102mm 4"	0171102ES	0171102ESC
114mm 4½"	0171114ES	0171114ESC
127mm 5"	0171127ES	0171127ESC
140mm 5½"	0171140ES	0171140ESC
152mm 6"	0171152ES	0171152ESC
178mm 7"	-	-
203mm 8"	0171203ES	-

- When using a straight stack, remember your raincap
- Nelson Exhaust is proud to offer a selection of Zinc or Chrome plated genuine 'Mercury' manufactured raincaps.
- The primary function of any raincap is to protect the muffler and exhaust system from rust and carbon residue.
- Our raincaps feature a single bolt mounting design and have been heavy duty welded for a longer service life.
- These raincaps are precision balanced and include nylon stops for a 'QUIET' operation.



POLISHED STAINLESS STEEL RAINCAPS

DESCRIPTION	PART NO
51mm 2"	RCSS051
63mm 2½"	RCSS063
76mm 3"	RCSS076
89mm 3½"	RCSS089
102mm 4"	RCSS102
127mm 5"	RCSS127
178mm 7"	RCSS178
203mm 8"	RCSS203



PARROP (CORRUGATED TUBE)

DESCRIPTION	PART NO
25mm S/S corrugated tube	PARROP 25
32mm S/S corrugated tube	PARROP 32
38mm S/S corrugated tube	PARROP 38
50mm S/S corrugated tube	PARROP 50
63mm S/S corrugated tube	PARROP 65
100mm S/S corrugated tube	PARROP 100
80mm S/S corrugated tube	PARROB 80
125mm S/S corrugated tube	PARROP 125
150mm S/S corrugated tube	PARROP 150
200mm S/S corrugated tube	PARROP 200



THERMO BLANKETS



Fitted Thermo Blanket

Thermo Blankets made to order

BENDS 30° STANDARD

OD x OD	CLR	ALUMIMISED STEEL	LEG LENGTH A
102mm 4"	127mm 5"	900077A	102mm (4")
127mm 5"	152mm 6"	900078A	102mm (4")
152mm 6"	254mm 10"	900079A	229mm (9")

Available in

- * stainless steel
- * mild steel
- * chrome plated
- * aluminised steel (1.6mm gauge)

(Also available expanded & notched)

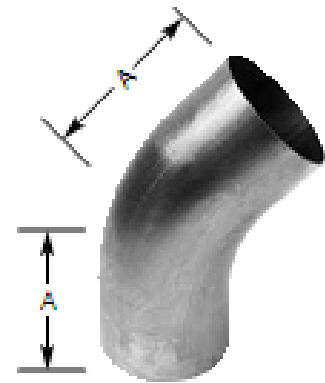

BENDS 45° STANDARD LONG LEG

OD	CLR	MILD STEEL	ALUMIMISED STEEL	LEG LENGTH A	LEG LENGTH B
63mm 2½"	95mm 3¼"	010306345	010360345A	300mm	600mm
76mm 3"	114mm 4½"	010307645	010307645A	295mm	550mm
89mm 3½"	134mm 5¼"	010308945	010308945A	300mm	550mm
102mm 4"	152mm 6"	010310245	010310245A	280mm	565mm
114mm 4½"	171mm 6¾"	010311445	010311445A	300mm	550mm
127mm 5"	203mm 8"	010312745	010312745A	320mm	530mm
152mm 6"	229mm 9"	010315245	010315245A	400mm	600mm

Available in

- * mild steel
- * aluminised steel (1.6mm gauge)

(Also available expanded & notched)

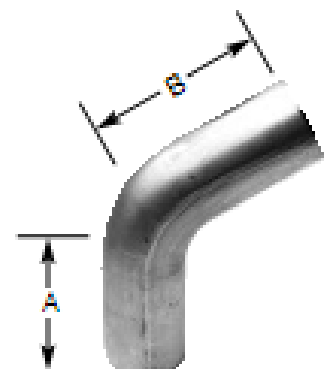

BENDS 45° STANDARD

OD	CLF	MILD STEEL	ALUMI-NISED STEEL	STAINLESS STEEL Type 304	STAINLESS STEEL Type 316	CHROME PLATED
25mm 1"	38mm 1½"	010102545	-	050102516AT	050102516BT	-
29mm 1⅛"	44mm 1¾"	010102945	-	-	-	-
32mm 1¼"	48mm 1⅞"	010103245	-	050103216AT	050103216BT	-
35mm 1⅜"	53mm 2⅛"	010103545	-	-	-	-
38mm 1½"	57mm 2¼"	010103845	010203845	050103816AT	050103816BT	-
41mm 1⅝"	76mm 3"	010104145	010204145	-	-	-
44mm 1¾"	66mm 2⅔"	010104445	010204445	050104416AT	050104416BT	-
48mm 1⅞"	72mm 2⅘"	010104845	010204845	-	-	-
51mm 2"	76mm 3"	010105145	010205145	050105116AT	050105116BT	-
54mm 2⅛"	81mm 3⅑"	010105445	-	-	-	-
57mm 2¼"	86mm 3⅒"	010105745	010205745	-	-	-
63mm 2½"	95mm 3¾"	010106345	010206345	050106316AT	050106316BT	-
70mm 2¾"	105mm 4⅒"	010107045	-	-	-	-
76mm 3"	114mm 4½"	010107645	010207645	050107616AT	050107616BT	-
89mm 3½"	134mm 5¼"	010108945	010208945	050108916AT	050108916BT	-
102mm 4"	152mm 6"	010110245	010210245	050110116AT	050110116BT	-
114mm 4½"	171mm 6¾"	010111445	010211445	-	-	-
127mm 5"	203mm 8"	010112745	010212745	050112716AT	050112716BT	CPB12745
152mm 6"	229mm 9"	010115245	010215245	050115216AT	050115216BT	-
178mm 7"	-	010117845	-	-	-	-

Available in

- * stainless steel
- * mild steel
- * chrome plated
- * aluminised steel (1.6mm gauge)

(Also available expanded & notched)



BENDS 60° STANDARD

OD x OD	CLR	MILD STEEL	ALUMIMISED STEEL	LEG LENGTH A
89mm 3½"	127mm 5"	010108960	900084A	203mm (8")
102mm 4"	127mm 5"	010110260	900085A	203mm (8")
127mm 5"	152mm 6"	010112760	900086A	203mm (8")
152mm 6"	254mm 10"	-	900087A	229mm (9")

Available in

- * stainless steel
- * mild steel
- * chrome plated
- * aluminised steel (1.6mm gauge)

(Also available expanded & notched)

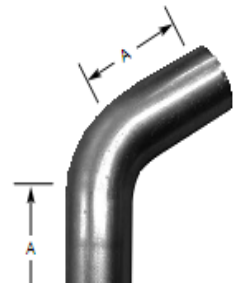

BENDS 90° CHROME PLATED

OD	CLR	CHROME PLATED PLAIN	CHROME PLATED EXPANDED/ NOTCHED	PLAIN
63mm 2½"	95mm 3¾"	CPB06390	-	-
76mm 3"	114mm 4½"	CPB07690	-	-
89mm 3½"	134mm 5¼"	CPB08990	-	-
102mm 4"	152mm 6"	CPB10290	-	-
114mm 4½"	171mm 6¾"	CPB11490	-	-
127mm 5"	203mm 8"	CPB12790	-	-
152mm 6"	229mm 9"	CPB15290	-	-

Available in

- * stainless steel
- * mild steel
- * chrome plated
- * aluminised steel (1.6mm gauge)

(Also available expanded & notched)

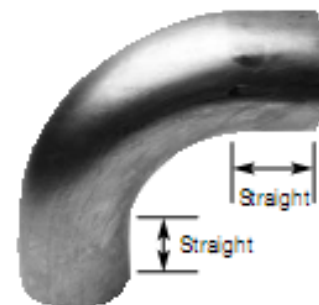

90° Bend

BENDS 90° STANDARD

OD	CLR	MILD STEEL	ALUM STEEL	STAINLESS STEEL TYPE 304	STAINLESS STEEL TYPE 316
25mm 1"	38mm 1½"	010102590	-	050102516CT	050102516DT
29mm 1⅛"	44mm 1¾"	010102990	-	-	-
32mm 1¼"	48mm 1⅞"	010103290	010203290	050103216CT	050103216DT
35mm 1⅜"	53mm 2⅛"	010103590	-	-	-
38mm 1½"	57mm 2¼"	010103890	010203890	050103816CT	050103816DT
41mm 1⅝"	76mm 3"	010104190	010204190	-	-
44mm 1¾"	66mm 2⅔"	010104490	010204490	050104416CT	050104416DT
48mm 1⅞"	72mm 2⅘"	010104890	010204890	-	-
51mm 2"	76mm 3"	010105190	010205190	050105116CT	050105116DT
54mm 2⅛	81mm 3⅓"	010105490	-	-	-
57mm 2¼"	86mm 3⅔"	010105790	010205790	050105716CT	050105716DT
63mm 2½"	95mm 3¾"	010106390	010206390	050106316CT	050106316DT
70mm 2¾"	105mm 4⅒"	010107090	-	-	-
76mm 3"	114mm 4½"	010107690	010207690	050107616CT	050107616DT
89mm 3½"	134mm 5¼"	010108990	010208990	050108916CT	050108916DT
102mm 4"	152mm 6"	010110290	010210290	050110116CT	050110116DT
114mm 4½"	171mm 6¾"	010111490	010211490	-	-
127mm 5"	203mm 8"	010112790	010212790	050112716CT	050112716DT
127mm 5"	203mm 8"	-	SL590AL	-	-
152mm 6"	229mm 9"	010115290	010215290	050115216CT	050115216DT
178mm 7"	267mm 10½"	010117890	010217890	-	-
203mm 8"	304.5mm 12"	-	-	050120316CT	050120316DT
254mm 10"	381mm 15"	-	-	050125416CT	-

Other sizes available on request

BENDS TIGHT RADIUS 90°

OD	CLR	MILD STEEL	ALUMI-NISED STEEL	CHROME PLATED PLAIN	CHROME PLATED EXPANDED & NOTCHED	LEG LENGTH A X B
63mm 2½"	63mm 2½"	016006390	-	-	-	-
76mm 3"	76mm 3"	016007690	016007690A	-	-	152 X 229mm
89mm 3½"	89mm 3½"	016008990	016008990A	-	-	165 x 229mm
102mm 4"	102mm 4"	016010290	016010290A	CPB10290SR	CPB10290SRX	178 x 254mm
127mm 5"	127mm 5"	016012790	016012790A	CPB12790SR	CPB12790SRX	203 x 437mm
127mm 5"	127mm 5"	-	-	CPB12790SR-L	CPB12790SR-LX	330 x 330mm
152mm 6"	152mm 6"	016015290	016015290A	CPB15290SR	CPB15290SRX	254 x 254mm

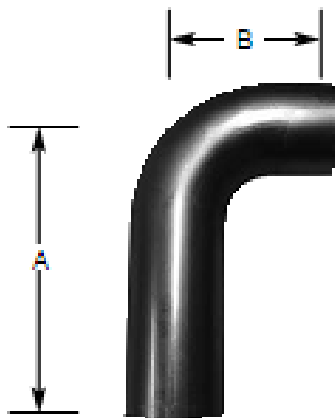

90° Tight Radius Bend

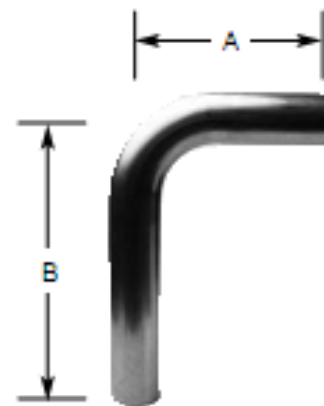

90° Standard Long Leg Bend

BENDS 90° STANDARD LONG LEG

OD	CLR	MILD STEEL	ALUMINISED STEEL	LEG LENGTH A	LEG LENGTH B
63mm 2½"	95mm 3¾"	010306390	010306390A	284mm	500mm
76mm 3"	114mm 4½"	010307690	010307690A	295mm	600mm
89mm 3½"	134mm 5¼"	010308990	010308990A	300mm	600mm
102mm 4"	152mm 6"	010310290	010310290A	350mm	570mm
114mm 4½"	171mm 6¾"	010311490	010311490A	388mm	543mm
127mm 5"	203mm 8"	010312790	010312790A	480mm	600mm
152mm 6"	229mm 9"	010315290	010315290A	400mm	600mm

BENDS 180° STANDARD

OD	CLR	MILD STEEL	ALUMINISED STEEL	LEG LENGTH A	LEG LENGTH B
25mm 1"	38mm 1½"	0101025180	-	101mm	101mm
29mm 1⅛"	44mm 1¾"	0101029180	-	120mm	120mm
32mm 1¼"	48mm 1⅞"	0101032180	-	122mm	122mm
35mm 1⅜"	53mm 2⅛"	0101035180	-	180mm	180mm
38mm 1½"	57mm 2¼"	0101038180	0102038180	167mm	167mm
41mm 1⅝"	76mm 3"	0101041180	0102041180	177mm	177mm
44mm 1¾"	66mm 2⅔"	0101044180	0102044180	190mm	190mm
48mm 1⅞"	72mm 2⅘"	0101048180	0102048180	198mm	198mm
51mm 2"	76mm 3"	0101051180	0102051180	202mm	202mm
54mm 2⅛"	81mm 3⅛"	0101054180	0102054180	240mm	240mm
57mm 2¼"	86mm 3⅜"	0101057180	0102057180	243mm	243mm
63mm 2½"	95mm 3¾"	0101063180	0102063180	290mm	290mm
70mm 2¾"	105mm 4⅛"	0101070180	-	330mm	275mm
76mm 3"	114mm 4½"	0101076180	0102076180	322mm	322mm
89mm 3½"	134mm 5¼"	0101089180	0102089180	415mm	340mm
102mm 4"	153mm 6"	0101102180	0102102180	255mm	255mm
127mm 5"	203mm 8"	0101127180	-	300mm	300mm



Available in

- * mild steel
- * aluminised steel (1.6mm gauge)

(Also available expanded & notched)

FLEXIBLE TUBE—3 MTR LENGTH

ID TUBE	STAINLESS STEEL
25mm 1"	0155025
32mm 1¼"	0155032
38mm 1½"	0155038
45mm 1 ⁷ / ₉ "	0155045
51mm 2"	0155051
57mm 2¼"	0155057
63mm 2½"	0155063
70mm 2¾"	0155070
76mm 3"	0155076
89mm 3½"	0155089
102mm 4"	0155102
114mm 4½"	0155114
127mm 5"	0155127
152mm 6"	0155152
203mm 8"	0155203
254mm 10"	0155254
305mm 12"	0155305

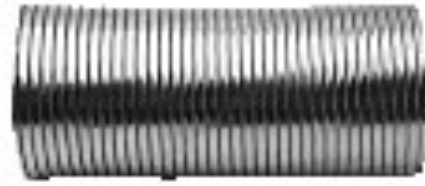

Sizes cut to length

ASSORTED TUBING



Mild Steel
Aluminized steel
Stainless Steel
Aluminium

1" to 10" diameter

Sizes cut to length

RIGID TUBE

TUBE OD	METRE LENGTH	MILD STEEL	ALUMINISED STEEL	ALUMINIUM	STAINLESS STEEL Type 304	STAINLESS STEEL Type 316
12.7mm	6.1	-	-	-	0551012.7FT	-
16mm 5/8"	6.1	0151016F	-	-	0551016FT	-
19mm 3/4"	6.1	0151019F	-	-	-	-
22mm 7/8"	6.1	0151022F	-	-	-	-
25mm 1"	6.1	0151025F	-	-	0551025FT	0552025FT
29mm 1 1/7"	6.1	0151029F	-	-	-	-
32mm 1 1/4"	6.1	0151032F	0152032F	-	0551032FT	0552032FT
35mm 1 3/8"	6.1	0151035F	0152035F	-	-	-
38mm 1 1/2"	6.1	0151038F	0152038F	-	0551038FT	0552038FT
41mm 1 5/8"	6.1	0151041F	0152041F	-	-	-
44mm 1 3/4"	6.1	0151044F	0152044F	-	0551044FT	0552044FT
48mm 1 7/8"	6.1	0151048F	0152048F	-	-	-
51mm 2"	6.1	0151051F	0152051F	0154051F	0551051FT	0552051FT
54mm 2 1/8"	6.1	0151054F	0152054F	-	-	-
57mm 2 1/4"	6.1	0151057F	0152057F	-	0551057FT	0552057FT
60mm 2 3/8"	6.1	0151060F	-	-	-	-
63mm 2 1/2"	6.1	0151063F	0152063F	0154063F	0551063FT	0552063FT
70mm 2 3/4"	6.1	0151070F	0152070F	-	-	-
76mm 3"	6.1	0151076F	0152076F	0154076F	0551076FT	0552076FT
89mm 3 1/2"	5.84	0151089F	0152089F	-	0551089FT	-
102mm 4"	5.84	0151102F	0152102F	0154102F-2	0551102FT	0552102FT
114mm 4 1/2"	2.92	0151114	0152114	-	-	-
127mm 5"	5.84	0151127F	0152127F	0154127F	0551127FT	0552127FT
152mm 6"	5.84	0151152F	0152152F	0154152F-1	0551152FT	0552152FT
178mm 7"	2.92	0151178	0152178	89665K	-	-
203mm 8"	2.92	0151203	0152203	-	-	-
203mm 8"	6.0	-	-	0154203F-1	0511203FT	-
254mm 10"	2.92	0151254	0152254	-	-	-

EXHAUST LAGGING

	DESCRIPTION	PART NO
10 metre roll	2" (50mm) wide	LAG002
(White)	3" (75mm) wide	LAG004
30 metre roll	1½" (40mm) wide	LAG001
(White)	2" (50mm) wide	LAG003
	3" (75mm) wide	LAG005
	4" (100mm) wide	LAG006
15 metre roll	2" (50mm) wide	LAG010
(Charcoal)		



CABLE TIES - STAINLESS STEEL

DESCRIPTION	PART NO
Cable Ties Stainless Steel 840mm	CTS840



METAL POLISH

PART NO	DESCRIPTION
X-MP-100	Dynasol Metal Polish 100g



EXHAUST CEMENT

PART NO	DESCRIPTION
Exhaust Putty	Muffler Cement 170gms
X-RGR-85	RTV Grey Silicone 85gms
X-RGR	RTV Grey Silicone 300gms



ALUMINIUM TAPE

PART NO	DESCRIPTION
TAPE 48 INSU	48mm x 50mtr Adhesive Aluminium Tape



FLEX (BELLOWS) CONNECTORS

DIAMETER	STAINLESS STEEL ID-ID PART NO
51mm 2"	89778K
63mm 2½"	89779K
70mm 2¾"	89785K
76mm 3"	89786K
89mm 3½"	89787K
102mm 4"	89788K
127mm 5"	89789K
152mm 6"	89790K



DIAMETER	STAINLESS STEEL ID-ID PART NO
50mm 2"	BEL050
65mm 2½"	BEL065
80mm 3"	BEL080
100mm 4"	BEL100
125mm 5"	BEL125
150mm 6"	BEL150
200mm 8"	BEL200
250mm 10"	BEL250
300mm 12"	BEL300
350mm 14"	BEL350
400mm 16"	BEL400
450mm 18"	BEL450



DIAMETER	STAINLESS STEEL ID-ID PART NO
1.5" x 6"	FLEXI-1.5x6
1.5" x 8"	FLEXI-1.5x8
1.75" x 6"	FLEXI-1.75x6
1.75" x 8"	FLEXI-1.75x8
1.75" x 10"	FLEXI-1.75x10
2" x 4.5"	FLEXI-2x4.5
2" x 6"	FLEXI-2x6
2" x 8"	FLEXI-2x8
2" x 10"	FLEXI-2x10
2.25" x 6" long	FLEXI-2.25x6
2.25" x 8" long	FLEXI-2.25x8
2.25" x 10" long	FLEXI-2.25x10
2.5" x 4"	FLEXI-2.5x4
2.5" x 6"	FLEXI-2.5x6
2.5" x 7"	FLEXI-2.5x7
2.5" x 10" long	FLEXI-2.5x10
3" x 6"	FLEXI-3x6
3" x 8"	FLEXI-3x8
3" x 10"	FLEXI-3x10
3.5" x 8" long	FLEXI-3.5x8
3.5" x 12"	FLEXI-3.5x12
4" x 8" long	FLEXI-4x8
4" x 12"	FLEXI-4x12
5" x 12"	FLEXI-5x12
6" X 12"	FLEXI-6x12



HEAVY DUTY AIR COMPRESSORS

Pacbrake’s Heavy Duty HP625 air compressors have a 100% duty cycle and are offered in two pump head configurations, vertical & horizontal. These 3/4 horsepower compressors have an oil-less design, sealed bearings, a PTFE piston ring, a copper wire wound permanent magnet motor and a cast steel cylinder with a hard anodized aluminium sleeve.

If you need onboard air for exhaust brakes, air horns, air seats, air suspension or just blowing up tyres then this is the system for you.



Part # HP10625V

**INSULATION KITS AVAILABLE ON REQUEST
Part # HP10116**

AIR TANK KITS

Working in conjunction with an air compressor, an air tank stores the compressed air and holds it until needed. Storing air allows for quicker product activation and is especially valuable when operating more than one product. Pacbrake offers three air tank sizes to meet everyone’s needs. 1/2 gallon tank, 2 1/2 gallon tank & 5 gallon tank. Each air tank kit comes complete with air tank airline, dryer and fittings.

- HP10053 1.9 litre tank
- HP 10050 9.5 litre tank
- HP 10051 19 litre tank

**Part # HP10050
Tank Only—Part # HP10093**



KENWORTH PRODUCTS

Kenworth cab-over exhaust elbow with bracket

DESCRIPTION	PART NO
Kenworth Chrome Female Bell	7001221CP
Kenworth Chrome Elbow	7001127CP
Kenworth Elbow Aluminized	7001127
Kenworth - LH Cab-Over Elbow - Painted	KW9045-L
Kenworth - RH Cab-Over Elbow - Painted	KW9045-R

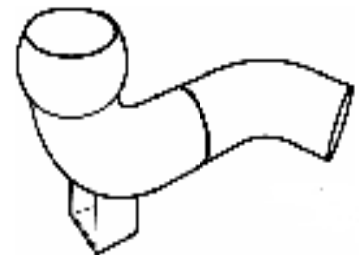

U-BOLT CLAMPS

DESCRIPTION	PART NO STAINLESS STEEL	PART NO ZINC
28mm	-	CLP028
32mm	-	CLP032
38mm	-	CLP038
41mm	-	CLP041
45mm	CLP045SS	CLP045
48mm	CLP048SS	-
51mm	CLP051SS	-
57mm	CLP057SS	-
63mm	CLP063SS	-
76mm	CLP076SS	-
102mm	CLP102SS	-
127mm	CLP127SS	-



Constant Torque—Spring Loaded

SUIT RUBBERWARE ID	PART NO
2.25-2.49"	TB100SL
2.69-2.93"	TB200SL
3.13-3.37"	90588K
3.63-3.87"	90599K
3.88-4.12"	TB500SL
4.13-4.37"	90600K
4.63-4.87"	90616K
5.13-5.37"	TB800SL



TORCITE BUTT CLAMP

NOMINAL ID	ALUMINISED	STAINLESS	STAINLESS
76mm 3"	-	90384A	-
89mm 3½"	-	90385A	-



HEAVY DUTY CLAMPS

NOMINAL ID	SINGLE BOLT ALUMINISED	SINGLE BOLT S/ LESS	FLAT ZINC	FLAT CHROE	ROUND ZINC	ROUND CHROME
45mm 1 ⁷ / ₉ "	-	-	-	-	0161CZ045	-
48mm 1 ⁷ / ₈ "	-	-	-	-	0161CZ048	-
51mm 2"	90869A	900016A	-	-	0161CZ051	0161CC051
54mm 2 ¹ / ₈ "	-	-	-	-	0161CZ054	0161CC054
57mm 2 ¹ / ₄ "	90870A	900017A	-	-	0161CZ057	0161CC057
63mm 2 ¹ / ₂ "	90871A	900018A	-	-	0161CZ063	0161CC063
70mm 2 ³ / ₄ "	90872A	900019A	-	-	-	-
76mm 3"	90873A	900003A	0161CZ076F	0161CC076F	0161CZ076	0161CC076
89mm 3 ¹ / ₂ "	90874A	900004A	0161CZ089F	0161CC089F	0161CZ089	0161CC089
102mm 4"	90875A	90885A	0161CZ102F	0161CC102F	0161CZ102	0161CC102
114mm 4 ¹ / ₂ "	90876A	SBPC114S	0161CZ114F	0161CC114F	0161CZ114	0161CC114
127mm 5"	90877A	90887A	0161CZ127F	0161CC127F	0161CZ127	0161CC127
127mm 5"	-	-	0161CZ127S#	-	-	-
152mm 6"	90878A	SBPC152S	0161CZ152F	0161CC152F	0161CZ152	0161CC152
178mm 7"	-	7001987SS	0161CZ178F	-	-	-
203mm 8"	-	-	-	-	0161CZ203	-

15mm saddle

WORM DRIVE HOSE CLAMPS

DESCRIPTION	PART NO
2" to 3"	HOSE CLAMP - 40
2 ⁵ / ₁₆ " to 3 ¹ / ₄ "	HOSE CLAMP - 44
2 ⁹ / ₁₆ " to 3 ¹ / ₂ "	HOSE CLAMP - 48
2 ³ / ₄ " to 3 ³ / ₄ "	HOSE CLAMP - 52
3 ⁵ / ₈ " to 4 ¹ / ₂ "	HOSE CLAMP - 64

DESCRIPTION	PART NO
4 ³ / ₄ " to 5"	HOSE CLAMP - 80
4 ³ / ₄ " to 5 ⁵ / ₈ "	HOSE CLAMP - 85
5 ³ / ₄ " to 5 ⁵ / ₈ "	HOSE CLAMP - 90
6 ³ / ₄ " to 7 ⁵ / ₈ "	HOSE CLAMP - 95

HEAVY DUTY CLAMPS



**STAINLESS STEEL
SINGLE BOLT CLAMPS**



FLAT BAND



Lap Type



Butt Type



Flat Band

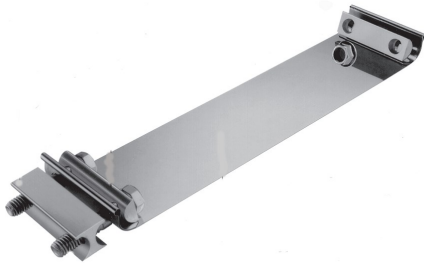

Easy Seal CLAMPS

Longer bolts and pre-attached hardware make wraparound installation each & accurate.

Patented design makes for fast, easy & accurate installation—there's no need to separate pipes or exhaust members before clamping.

UNIVERSAL GRAB HANDLES

PART NO	LENGTH	
89775K	600mm	23 ³ / ₅ "

Available in polished Stainless Steel or Chrome plated.



HEAVY DUTY CLAMPS

TORCITE LAP CLAMP

NOMINAL ID	WIDE BAND ALUMINISED	WIDE BAND STAINLESS	FLAT BAND STAINLESS
51mm 2"	90350A	90360A	89521K
57mm 2¼"	90351A	90361A	89522K
63mm 2½"	90352A	90362A	89523K
70mm 2¾"	90353A	90363A	89524K
76mm 3"	90354A	90364A	89525K
89mm 3½"	90355A	90365A	89526K
102mm 4"	90356A	90366A	89527K
114mm 4½"	90357A	90367A	90464K
127mm 5"	90358A	90368A	89528K
152mm 6"	90359A	90369A	89529K
178mm 7"	-	-	ES-700
203mm 8"	-	-	ES-800



SPARE PARTS FOR CLAMPS

WBC001H
For Wide Band



SBC001H
For Single Bolt



TUBE CONNECTOR, CLAMP & FLANGE KIT

TUBE OD	CLAMP & FLANGE KIT
127mm (5")	90893K

T-BOLT CLAMPS Standard Stainless Steel

SUIT RUBBERWARE ID	ACTUAL CLAMP ID	STANDARD CLAMP
51mm 2.0"	2.25-2.50"	3316653S
64mm 2.5"	2.75-3.06"	3316654S
76mm 3.0"	3.25-3.56"	3316656S
89mm 3.5"	3.75-4.06"	3316657S
102mm 4.0"	4.25-4.56"	3316658S
114mm 4.5"	4.75-5.06"	3316659S
127mm 5.0"	5.25-5.56"	3316660S
140mm 5.5"	5.75-6.06"	3316661S
152mm 6.0"	6.38-6.69"	3316662S
165mm 6.5"	-	-
178mm 7.0"	7.25-7.76"	3316663S
203mm 8.0"	8.50-8.81"	3316664S
254mm 10.0"	10.50-11.00"	3316665S
254mm 10.0"	10.25-10.75"	3316666S



T-BOLT CLAMP LONG BOLT

DESCRIPTION	PART NO
70mm 2.75"	P148340
89mm 3.5"	P148342
152mm 6.0"	P148347
178mm 7.0"	P148348
203mm 8.0"	P148349

CONSTANT TORQUE WORM DRIVE CLAMP

DESCRIPTION	PART NO
57-59mm	P532925
70-92mm	P532926
83-105mm	P532927
95-117mm	P532928
108-130mm	P532929



V-BAND CLAMPS

TUBE OD	PART NO	TYPICAL APPLIC	A	B	C	D	E	F	MAX FLANGE OD
2.50"	90603K	DD8.2T 8920206	40°	2.88 73mm	.207 5mm	.75 19mm	.28 7mm	.050 1mm	2.75 70mm
2.75"	89571K	Cummins B	40°	3.22 82mm	0.26 7mm	0.85 22mm	0.14 4mm	0.05 1mm	3.13 80mm
3.00"	89530K	Ford D9HT-51210-DA	40°	3.87 99mm	0.43 11mm	0.88 22mm	0.31 8mm	0.361 8mm	3.75 95mm
3.00"	89505K	DD 6V71	40°	3.82 97mm	0.21 5mm	0.88 22mm	0.28 7mm	0.08 2mm	3.70 94mm
3.00"	89500K	Cummins V903 Ford 370 & 429 E5HZ-5A321-B	40°	3.88 99mm	0.40 10mm	0.88 22mm	0.28 7mm	0.05 1mm	3.76 96mm
3.13"	89511K	OE Muffler	40°	3.96 101mm	.207 5mm	.88 22mm	.28 7mm	.080 2mm	3.84 98mm
3.50"	89573K	Cummins C	40°	4.12 105mm	0.26 7mm	0.67 17mm	0.14 4mm	0.05 1mm	4.03 102mm
3.50"	89531K	Cat 3208T Ford 6.6, 7.8 F2HT5A212AA	40°	4.19 106mm	0.40 10mm	0.88 22mm	0.28 7mm	0.05 1mm	4.07 103mm
3.50"	89506K	DD8V71	40°	4.25 108mm	0.40 10mm	0.88 22mm	0.28 7mm	0.05 1mm	4.16 106mm
3.50"	89501K	Cummins VT555	40°	4.25 108mm	0.40 10mm	0.88 22mm	0.28 7mm	0.05 1mm	4.16 106mm
3.50"	89512K	IH DT466 & Connector Ends	40°	4.31 109mm	.207 5mm	.88 22mm	.28 7mm	.080 2mm	4.19 106mm
4.00"	89508K	DD 8.2N	40°	4.06 103mm	0.24 6mm	0.88 22mm	0.29 7mm	0.08 2mm	3.94 100mm
4.00"	89520K	Cat 3126T & 3176T Cummins L10 Cummins M11	40°	4.75 121mm	0.40 10mm	14 25mm	0.28 7mm	0.05 1mm	4.63 118mm
4.00"	89509K	DD 8.2T GM 2295978	40°	4.75 121mm	0.16 4mm	0.88 22mm	0.31 8mm	0.08 2mm	4.63 118mm
4.00"	89532K	Mack 11ME29	40°	4.94 126mm	0.18 5mm	0.75 19mm	0.28 7mm	0.06 2mm	4.82 122mm
4.00"	89502K	Switzer 4LDE	40°	4.50 114mm	0.26 7mm	0.75 19mm	0.44 4mm	0.05 1mm	4.41 122mm
4.00"	89507K	DD 6-71	40°	4.91 125mm	0.29 7mm	1.13 29mm	0.30 8mm	0.09 2mm	4.79 122mm
4.00"	89533K	Mack 48RU2341	40°	4.61 117mm	0.16 4mm	0.75 19mm	0.22 6mm	0.05 1mm	4.49 114mm
4.00"	89513K	Connector Ends	40°	4.81 122mm	.207 5mm	.88 22mm	.28 7mm	.080 2mm	4.69 119mm
4.88"	89510K	DD 8V71T	40°	5.25	0.26	0.75	0.14	0.05	5.16
		6V92T 8V92T	40°	133mm	7mm	19mm	4mm	1mm	131mm

V-BAND CLAMPS

TUBE OD	PART NO	TYPICAL APPLIC	A	B	C	D	E	F	MAX FLANGE OD
5.00"	89503K	Cummins T50 Turbo, M-11	40°	5.88 149mm	0.40 10mm	0.88 22mm	0.28 7mm	0.05 1mm	5.79 147mm
5.00"	89514K	Connector Ends	40°	5.81 148mm	0.21 5mm	0.88 22mm	0.28 7mm	0.08 2mm	5.69 145mm
5.00"	90530K	DD 8V71 Special Manifold	40°	5.87 149mm	0.37 9mm	0.88 22mm	0.30 8mm	0.05 1mm	5.75 146mm
5.25"	90531K	DD 8V71	40°	5.91 150.3mm	0.29 7.44mm	0.87 22.22mm	0.29 7.51mm	0.09 2.28mm	
5.25"	89504K	T50 Housing	40°	6.76 172mm	1.67 42mm	1.88 48mm	.281 7mm	.060 1.5mm	6.64 169mm

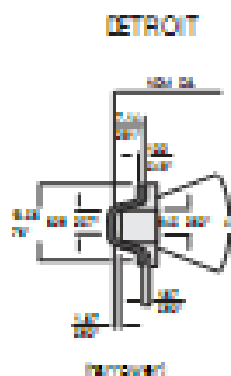
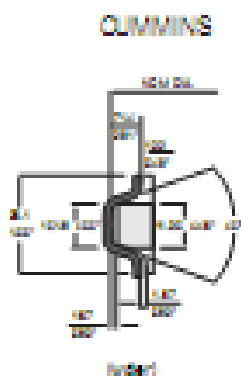
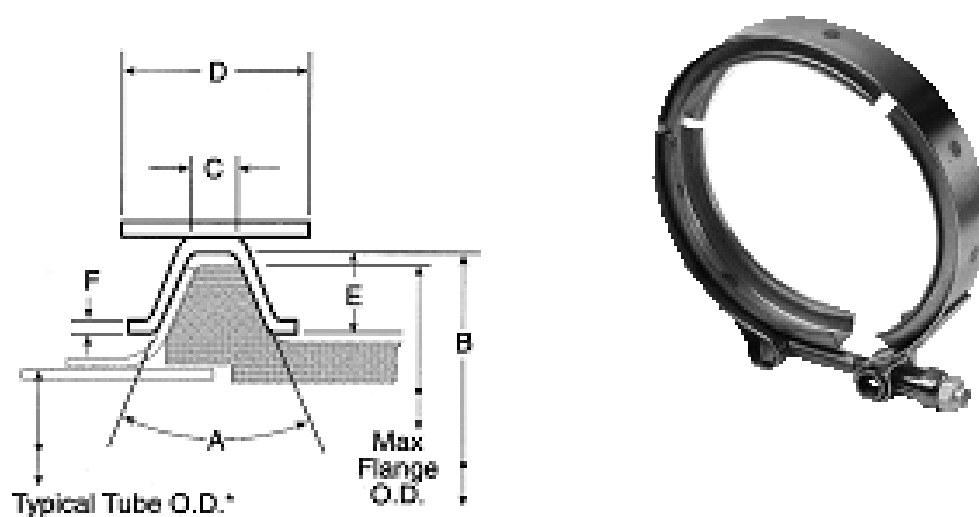

- V-Band Clamps are made of Type 321 Stainless Steel
- The function of a V-Band clamp is to connect the manifold or turbocharger to the exhaust system
- These type of clamps are designed to cater to the majority of engine applications and are available in a variety of sizes.

SINGLE COUPLERS

DIMENSIONAL DATA OD/ID	MILD STEEL	ALUMINISED STEEL	STAINLESS Type 304	STAINLESS Type 316
51mm 2"	0111SC051	0111SC051A	SC051.S	SC051.SS
54mm 2 1/8"	0111SC054	0111SC054A	-	-
57mm 2 1/4"	0111SC057	0111SC057A	-	-
63mm 2 1/2"	0111SC063	0111SC063A	SC063.S	SC063.SS
70mm 2 3/4"	0111SC070	0111SC070A	-	-
76mm 3"	0111SC076	0111SC076A	SC076.S	SC076.SS
89mm 3 1/2"	0111SC089	0111SC089A	SC089.S	SC089.SS
102mm 4"	0111SC102	0111SC102A	SC102.S	SC102.SS
114mm 4 1/2"	0111SC114	0111SC114A	-	-
127mm 5"	0111SC127	0111SC127A	SC127.S	SC127.SS
140mm 5 1/2"	0111SC140	0111SC140A	-	-
152mm 6"	0111SC152	0111SC152A	SC152.S	SC152.SS
178mm 7"	0111SC178	-	-	-

OD/ID

51mm
57mm
63mm
70mm
76mm
89mm
102mm
114mm
127mm
140mm
152mm

**OVERALL
LENGTH**

100mm
100mm
100mm
105mm
102mm
102mm
105mm
102mm
102mm
100mm
102mm

**EXPANDED
LENGTH**

55mm
55mm
55mm
56mm
62mm
60mm
65mm
60mm
60mm
55mm
60mm

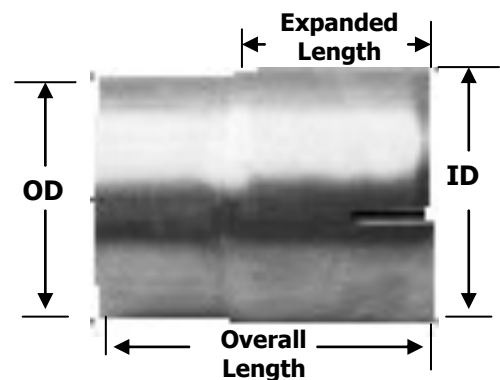

- Weld one end, U-Bolt other
- Connects OD & ID pipes of the same size.

STRAIGHT TUBE COUPLERS

DIMENSIONAL DATA OD/ID	MILD STEEL	ALUMINISED STEEL	STAINLESS Type 304	STAINLESS Type 316
51mm 2"	0111TC051	0111TC051A	STC051.S	STC051.SS
54mm 2 1/8"	0111TC054	0111TC054A	-	-
57mm 2 1/4"	0111TC057	0111TC057A	-	-
63mm 2 1/2"	0111TC063	0111TC063A	STC063.S	STC063.SS
70mm 2 3/4"	0111TC070	0111TC070A	-	-
76mm 3"	0111TC076	0111TC076A	STC076.S	STC076.SS
89mm 3 1/2"	0111TC089	0111TC089A	STC089.S	STC089.SS
102mm 4"	0111TC102	0111TC102A	STC102.S	STC102.SS
114mm 4 1/2"	0111TC114	0111TC114A	-	-
127mm 5"	0111TC127	0111TC127A	STC127.S	STC127.SS
140mm 5 1/2"	0111TC140	0111TC140A	-	-
152mm 6"	0111TC152	0111TC152A	STC152.S	STC152.SS
178mm 7"	0111TC178	-	-	-

- U-Bolt both ends
- Connects OD pipes of the same

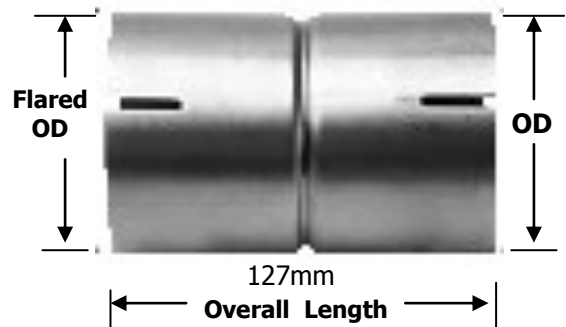

BEADED COUPLER

OD / OD	MILD STEEL
102mm	BC102
127mm	BC127

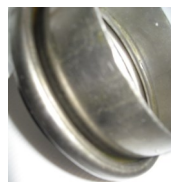

VOLVO BEADED COUPLER

OD / OD	MILD STEEL	STAINLESS STEEL
102mm	-	BC102V-SS
114mm	-	BC114V
127mm	BC127	BC127V-SS

LIPPED FLANGES

DIMENSIONAL DATA OD/ID	MILD STEEL	ALUMINISED STEEL	STAINLESS Type 304
51mm 2"	0111LF051	0111LF051A	LF051.S
54mm 2 ¹ / ₈ "	0111LF054	0111LF054A	-
57mm 2 ¹ / ₄ "	0111LF057	0111LF057A	-
63mm 2 ¹ / ₂ "	0111LF063	0111LF063A	LF063.S
70mm 2 ³ / ₄ "	0111LF070	0111LF070A	-
76mm 3"	0111LF076	0111LF076A	LF076.S
89mm 3 ¹ / ₂ "	0111LF089	0111LF089A	LF089.S
102mm 4"	0111LF102	0111LF102A	LF102.S
114mm 4 ¹ / ₂ "	0111LF114	0111LF114A	-
127mm 5"	0111LF127	0111LF127A	LF127.S
140mm 5 ¹ / ₂ "	0111LF140	0111LF140A	-
152mm 6"	0111LF152	0111LF152A	LF152.S

OD

51mm
57mm
63mm
76mm
89mm
102mm
114mm
127mm
152mm

FLARED OD

66mm
71mm
80mm
91mm
105mm
119mm
131mm
144mm
175mm

OVERALL LENGTH

70mm
70mm
70mm
78mm
76mm
78mm
80mm
80mm
78mm

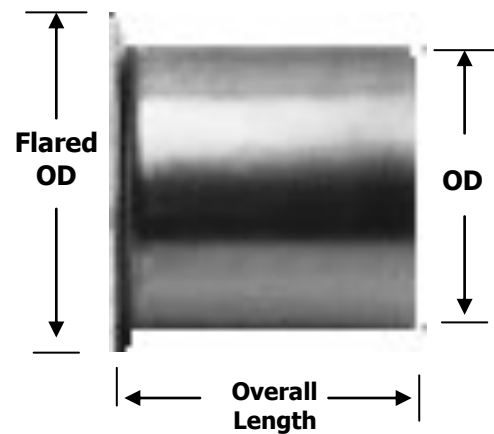

- Designed for use with V-Band Clamps.
- Standard 20° lip angle.

EXPANDED LIPPED FLANGES

DIMENSIONAL DATA OD/ID	MILD STEEL	ALUMINISED STEEL	STAINLESS Type 304
51mm 2"	0111LX051	0111LX051A	XLF051.S
54mm 2 1/8"	0111LX054	0111LX054A	-
57mm 2 1/4"	0111LX057	0111LX057A	-
63mm 2 1/2"	0111LX063	0111LX063A	XLF063.S
70mm 2 3/4"	0111LX070	0111LX070A	-
76mm 3"	0111LX076	0111LX076A	XLF076.S
89mm 3 1/2"	0111LX089	0111LX089A	XLF089.S
102mm 4"	0111LX102	0111LX102A	XLF102.S
114mm 4 1/2"	0111LX114	0111LX114A	-
127mm 5"	0111LX127	0111LX127A	XLF127.S
140mm 5 1/2"	0111LX140	0111LX140A	-
152mm 6"	0111LX152	0111LX152A	XLF152.S

OD	FLARED OD	OVERALL LENGTH	EXPANDED LENGTH
51mm	66mm	75mm	30mm
57mm	71mm	75mm	30mm
63mm	80mm	70mm	30mm
76mm	91mm	80mm	30mm
89mm	105mm	75mm	30mm
102mm	119mm	82mm	35mm
127mm	144mm	80mm	35mm
152mm	175mm	75mm	25mm

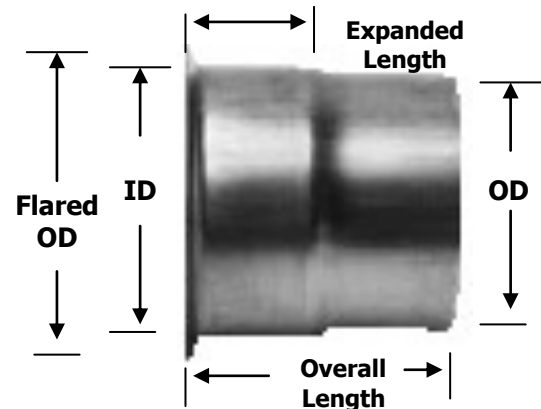

CONES

OD (A)	OD (B)	LENGTH	MILD STEEL	ALUMINISED STEEL
25mm	51mm	50mm	-	-
51mm	76mm	92mm	-	CONE001A
51mm	76mm	127m	CONE001	-
76mm	102mm	195m	CONE002	-
89mm	127mm	152mm	CONE003	-
70mm	127mm	110m	CONE007	-
102mm	152mm	149mm	CONE005	-



Used to connect tubing of different diameters.

EXPANDED ADAPTORS

OD	OD	MILD STEEL	ALUMINISED STEEL	STAINLESS Type 304	STAINLESS Type 316
38mm (1½") x	51mm (2")	0111XA0382	-	-	-
51mm x	57mm (2¼")	0111XA0511	0111XA0511A	XA0511.S	XA0511.SS
(2")	63mm (2½")	0111XA0512	0111XA0512A	XA0512.S	XA0512.SS
	76mm (3")	0111XA0513	0111XA0513A	XA0513.S	XA0513.SS
57mm x	63mm (2½")	0111XA057	0111XA057A	-	-
(2¼")	76mm (3")	0111XA0571	0111XA0571A	-	-
63mm x	70mm (2¾")	0111XA0631	0111XA0631A	XA0631.S	XA0631.SS
(2½")	76mm (3")	0111XA063	0111XA063A	XA063.S	XA063.SS
70mm (2¾") x	76mm (3")	0111XA070	-	-	-
76mm x	89mm (3½")	0111XA0761	0111XA0761A	XA0761.S	XA0761.SS
(3")	102mm (4")	0111XA0762	0111XA0762A	XA0762.S	XA0762.SS
89mm (3½") x	102mm (4")	0111XA089	0111XA089A	XA089.S	XA089.SS
102mm x	114mm (4½")	0111XA1021	0111XA1021A	XA1021.S	XA1021.SS
(4")	127mm (5")	0111XA102	0111XA102A	XA102.S	XA102.SS
110mm (4¼") x	127mm (5")	0111XA110	0111XA110A	-	-
114mm (4½") x	127mm (5")	0111XA114	0111XA114A	-	-
127mm x	140mm (5½")	0111XA1271	0111XA1271A	XA1271.S	XA1271.SS
(5")	152mm (6")	0111XA127	0111XA127A	XA127.S	XA127.SS

ID X ID	OVERALL LENGTH	EXPANDED LENGTH (A)	EXPANDED LENGTH (B)
51 x 57mm	127mm	60mm	55mm
51 c 63mm	127mm	60mm	50mm
51 x 76mm	135mm	65mm	42mm
57 x 63mm	130mm	70mm	55mm
57 x 76mm	135mm	57mm	45mm
63 x 70mm	135mm	50mm	75mm
63 x 76mm	130mm	55mm	65mm
70 x 76mm	140mm	60mm	75mm
76 x 89mm	127mm	60mm	55mm
76 x 102mm	127mm	55mm	45mm
89 x 102mm	127mm	55mm	60mm
102 x 114mm	127mm	50mm	45mm
102 x 127mm	127mm	50mm	45mm
110 x 127mm	127mm	50mm	60mm
114 x 127mm	127mm	65mm	55mm
127 x 140mm	127mm	65mm	55mm
127 x 152mm	127mm	55mm	45mm

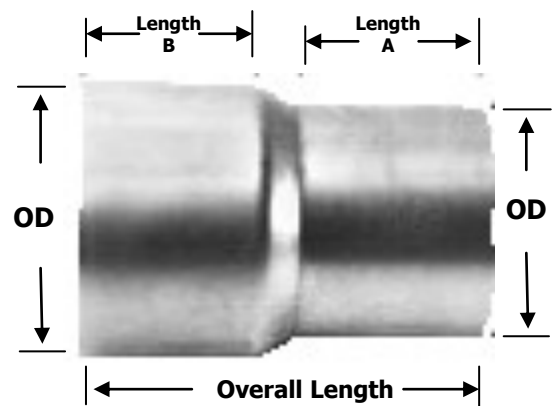

- Butt weld each end
- Reduces larger OD pipe to smaller OD pipe

EXPANDED ADAPTORS

DESCRIPTION	PART NO
Adaptor 7" ID to 5" OD	EXA7ID5OD
Adaptor 7" ID to 6" OD	EXA7ID6OD
Adaptor 7" OD to 5" OD	EXA7OD5OD
Adaptor 7" OD to 6" OD	EXA7OD6OD
Adaptor 8" ID to 5" OD	EXA8ID5OD
Adaptor 8" ID to 6" OD	EXA8ID6OD
Adaptor 8" OD to 5" OD	EXA8OD5OD
Adaptor 8" OD to 6" OD	EXA8OD6OD

Adaptors can be expanded to your requirements

45° EXPANDED JUNCTION

DIAMETER A (ID)	DIAMETER B (OD)	LENGTH C	LENGTH D	MILD STEEL	ALUMINISED STEEL
51mm	76mm	241.5mm	159mm	0111JX051	-
57mm	76mm	254mm	159mm	0111JX057	0111JX057A
63mm	102mm	267mm	178mm	0111JX063	0111JX063A
76mm	102mm	279.5mm	190.5mm	0111JX076	0111JX076A
89mm	127mm	292mm	209.5mm	0111JX089	0111JX089A
102mm	127mm	317.5mm	216mm	0111JX102	0111JX102A

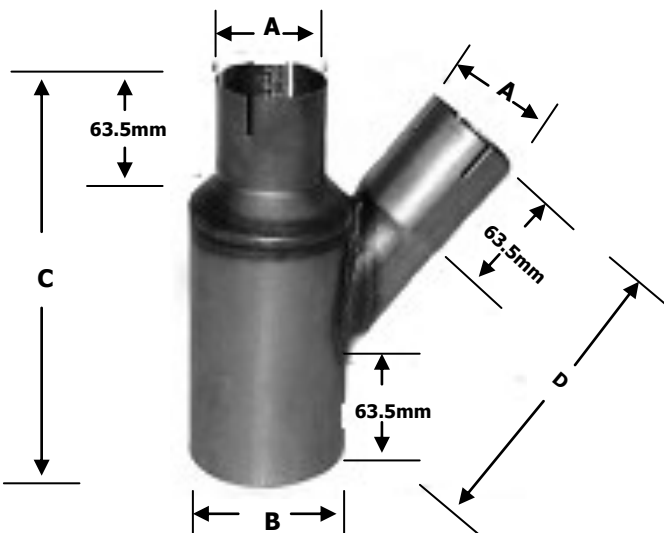

- Available in
 - MILD STEEL
 - ALUMINISED STEEL
- Can be used to convert a dual exhaust to single exhaust system

"Y" JUNCTIONS

OD x 2 x ID	MILD STEEL	ALUMINISED STEEL	CHROME PLATED
63mm	0111JY063	0111JY063A	-
76mm	0111JY076	0111JY076A	-
89mm	0111JY089	0111JY089A	-
102mm	0111JY102	0111JY102A	0111JY102C
114mm	0111JY114	0111JY114A	0111JY114C
127mm	0111JY127	0111JY127A	0111JY127C
152mm	0111JY152	0111JY152A	0111JY152C

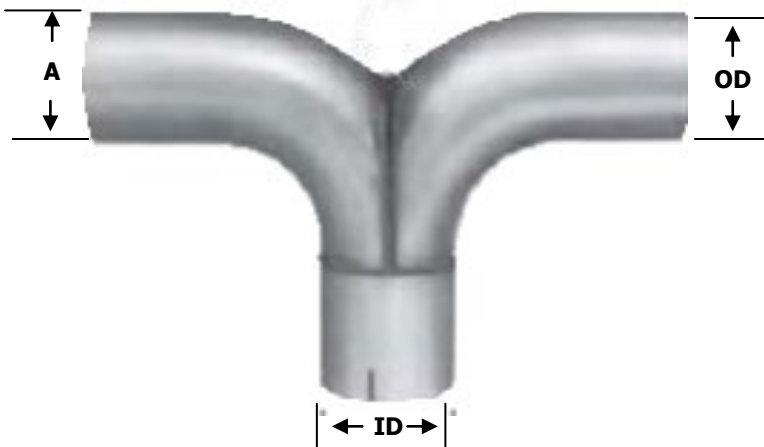

- Available in
 - MILD STEEL
 - ALUMINISED STEEL
 - CHROME PLATED
- Converts a single system exhaust pipe in a dual system.
- Purpose of "Y" junction to provide equal gas flow in both exhaust stacks.

WESTERN STAR 7-PIECE

PART #	DESCRIPTION
YP/WSTAR	Western Star Y-Piece Early
YP/WSTAR01	Western Star Y-Piece Late 08

DONUTS

Tube Diameter		Gauge	Mild Steel	Stainless steel	Aluminium
38mm	1½"	1.6mm	0190038	SSD038	ALD038
44mm	1¾"	1.6mm	0190044	-	ALD044
51mm	2"	1.6mm	0190051	SSD051	ALD051
57mm	2¼"	1.6mm	0190057	SSD057	ALD057
63mm	2½"	1.6mm	0190063	SSD063	ALD063
76mm	3"	2.0mm	0190076	SSD076	ALD076
89mm	3½"	2.0mm	0190089	SSD089	ALD089
102mm	4"	2.0mm	0190102	SSD102	ALD102
114mm	4½"	2.0mm	0190114	-	-
127mm	5"	2.0mm	0190127	SSD127	ALD127
152mm	6"	2.0mm	0190152	SSD152	ALD152
178mm	7"	2.0mm	0190178	SSD178	ALD178
178mm	7"	2.0mm	0190178D45	-	-
178mm	7"	2.0mm	0190178D90	-	-
203mm	8"	2.5mm	0190203	SSD203	ALD203
203mm	8"	2.5mm	0190203D45	-	-
203mm	8"	2.5mm	0190203D90	-	-
254mm	10"	2.5mm	0190254	-	-
254mm	10"	2.5mm	0190254D45	-	-
254mm	10"	2.5mm	0190254D90	-	-

- Used where special angles are required.
- Cut angles are available for special orders.



FLAME PROOF TANKER KITS

Flame Proof Tanker Kits are designed to conform to Australian Standard AS2809.1 and AS2809.2

A **Standard kit** consists of

- stainless steel top & bottom shroud
- stainless steel transition cap
(1 large, 1 small)
- bracket mounting rings (2)
- muffler pipe mounting brackets (2)
- chrome plated straight stack
- chrome plated silent raincap

Can be ordered with a deflector instead of straight stack & raincap.

Pipe shrouds are supplied in a "kit" form.

Also available **Pipe shroud kits** in short length 1500mm and long length 2290mm in sizes to suit 3" to 5" tube.

The **Short kit** consists of

- one transition cap
- two shrouds
- one connect ring
- one mounting ring/bracket
- one set of pipe support brackets

The **Long kits** consists of

- one transition cap
- three shrouds
- two connection rings
- one mounting ring/bracket
- three sets of pipe support brackets.

Top shrouds have an unperforated band near one end. This allows shortening of the shroud by 200mm if required for your application.

Shrouds listed are supplied **without** transition caps, mounting rings or support brackets.

- these must be ordered separately if required
- shrouds will be assembled for transport if requested.

Tanker Kit Exhaust Stacks are 1 metre long to allow for extra clearance for a raincap to fully open without touching the top transition cap. Longer stacks or deflectors can be used if required.

Pipe Shroud Connect Rings joins pipe shroud sections in pipe shroud kits.

Spare parts are available separately.

FLAME PROOF TANKER KITS

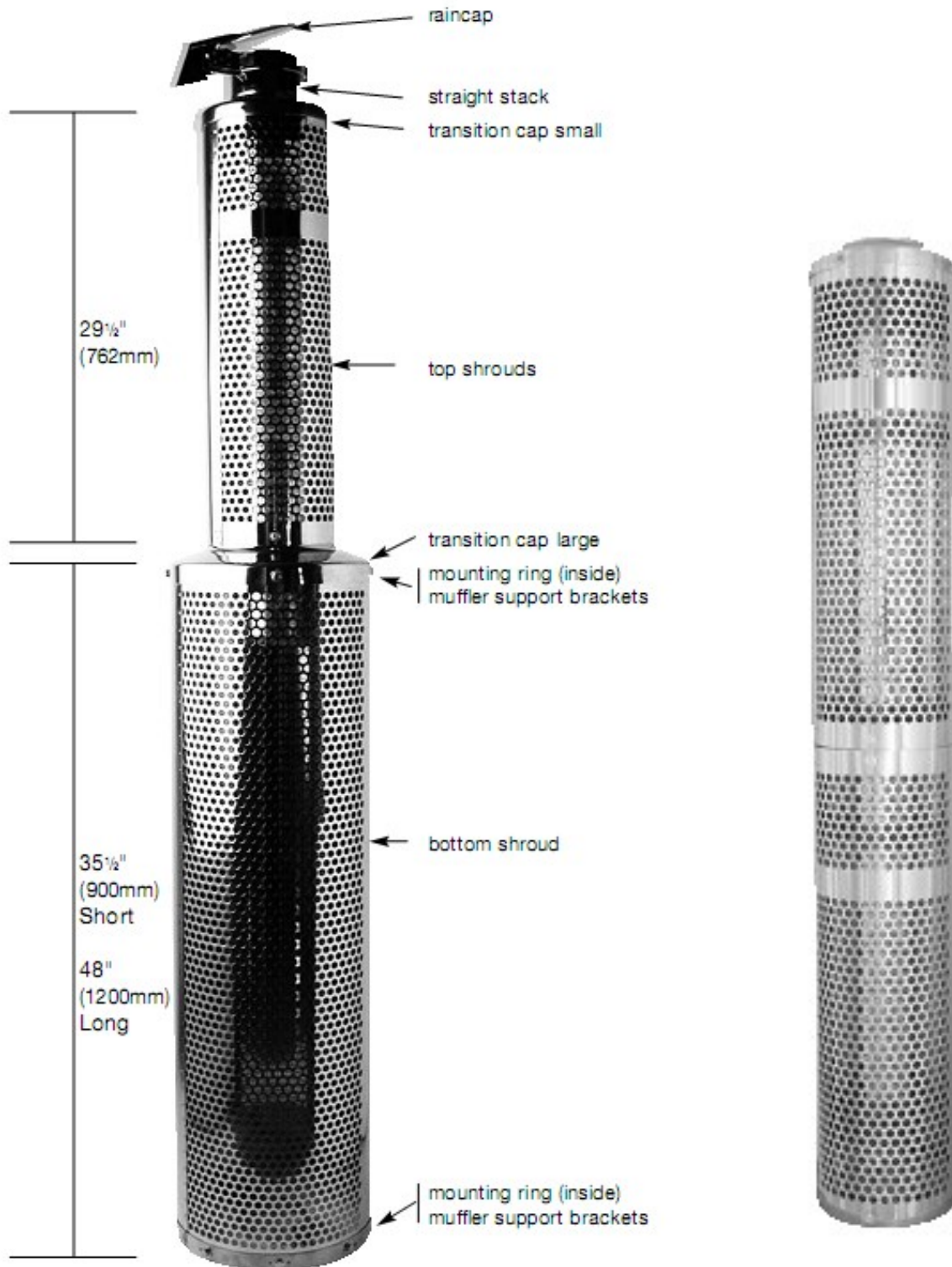

Mufflers must be ordered separately if required

FLAME PROOF TANKER KITS

FLAME PROOF TANKER KITS		
EXHAUST SIZE		POLISHED STAINLESS STEEL
76mm	3"	0134076T
89mm	3½"	0134089T
102mm	4"	0134102T
114mm	4½"	0134114T
127mm	5"	0134127T
127mm	5"	TK127-D (Deflector)
127mm	5"	TK127LV (Volvo)
152mm	6"	0134152T

TANKER KIT EXHAUST STACKS	
TUBE OD X LENGTH	CHROME PLATED MILD STEEL
76 x 1000mm	CPS076X1000P
102 x 1000mm	CPS102X1000P
114 x 1000mm	CPS114X1000P
127 x 1000mm	CPS127X1000P
152 x 1000mm	CPS152X1000P

PIPE SHROUD KITS

SHORT			LONG		
SUIT PIPE OD	DIAM X O/A LENGTH	POLISHED STAINLESS STEEL	SUIT PIPE OD	DIAM X O/A LENGTH	POLISHED STAINLESS STEEL
76mm 3"	203 x 1540mm	0134TSS076	76mm 3"	203 x 2290mm	0134TSL076
102mm 4"	203 x 1540mm	0134TSS102	102mm 4"	203 x 2290mm	0134TSL102
114mm 4½"	229 x 1540mm	0134TSS114	114mm 4½"	229 x 2290mm	0134TSL114
127mm 5"	229 x 1540mm	0134TSS127	127mm 5"	229 x 2290mm	0134TSL127
			152mm 6"	356 x 229mm	0134TSL152

TRANSITION CAPS

SHORT			LONG		
SUIT KIT SIZE	OD X ID	STAINLESS STEEL	SUIT KIT SIZE	OD X ID	STAINLESS STEEL
76mm 3"	203 x 76mm	0134TCS076	76mm 3"	305 x 203mm	0134TCL076
89mm 3½"	203 X 102mm	0134TCS089	89mm 3½"	356 X 203mm	0134TCL089
102mm 4"	203 x 102mm	0134TCS102	102mm 4"	356 x 203mm	0134TCL102
114mm 4½"	229 x 114mm	0134TCS114	114mm 4½"	356 x 229mm	0134TCL114
127mm 5"	229 x 127mm	0134TCS127	127mm 5"	356 x 229mm	0134TCL127
152mm 6"	254 x 152mm	0134TCS152	152mm 6"	356 x 229mm	0134TCL152

FLAME PROOF TANKER KITS

SHROUDS - TOP			SHROUDS - BOTTOM		
SUIT KIT SIZE	TRANSITION CAP	STAINLESS STEEL	SUIT KIT SIZE	TRANSITION CAP	STAINLESS STEEL
76mm 3"	no t/cap	0134TST076	76mm 3"	no t/cap	0134TSB076
76mm 3"	with t/cap	0134TST076C	89mm 3½"	no t/cap	0134TSB089
89mm 3½"	no t/cap	0134TST089	102mm 4"	no t/cap	0134TSB102
102mm 4"	no t/cap	0134TST102	102mm 4"	with t/cap + mounting ring	0134TSB102C
102mm 4"	with t/cap	0134TST102C	114mm 4½"	no t/cap	0134TSB114
114mm 4½"	no t/cap	0134TST114	114mm 4½"	with t/cap + mounting ring	0134TSB114C
114mm 4½"	with t/cap	0134TST114C	127mm 5"	no t/cap	0134TSB127
127mm 5"	no t/cap	0134TST127	127mm 5"	with t/cap + mounting ring	0134TSB127C
127mm 5"	with t/cap	0134TST127C	127mm 5"	1500mm	TKBS356L
152mm 6"	no t/cap	0134TST152	152mm 6"	no t/cap	0134TSB152
152mm 6"	with t/cap	0134TST152C	152mm 6"	with t/cap + mounting ring	0134TSB152C

MUFFLER SUPPORT BRACKETS

SUIT KIT SIZE	PIPE x SHROUD DIAMETER	ZINC PLATED
76mm 3"	76 x 305mm	0134GB076E
89mm 3½"	89 x 356mm	0134GB089F
102mm 4"	102 x 356mm	0134GB102F
114mm 4½"	114 x 229mm	0134GB114D
114mm 4½"	114 x 356mm	0134GB114F
127mm 5"	127 x 229mm	0134GB127D
127mm 5"	127 x 356mm	0134GB127F
152mm 6"	152 x 356mm	0134GB152F

PIPE SHROUD CONNECT RINGS

SUIT KIT SIZE	GUARD DIAMETER (OD)	ZINC PLATED
76/102mm 3"/4"	203mm	PSR08
114/127mm 4½"/5"	229mm	PSR09

MUFFLERS



Mufflers are available in 3 different styles

- Heavy Duty
- Universal Reactive
- Mid Range

Designed & manufactured in Australia

MUFFLER STYLE CHART

EXTERNAL CONFIGURATION



Style A

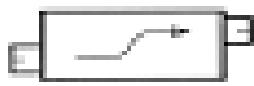

Style B



Style C



Style D

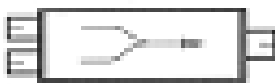

Style E



Style F



Style G

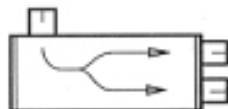

Style H

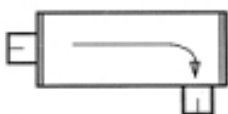

Style I



Style J

INTERNAL CONFIGURATION



Style A

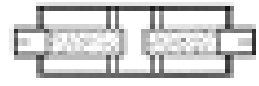

Style B

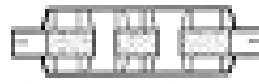

Style C



Style D



Style E



Style F

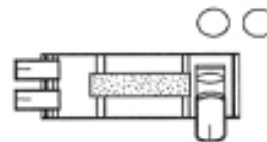

Style G

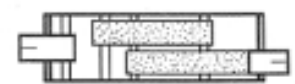

Style H



Style I

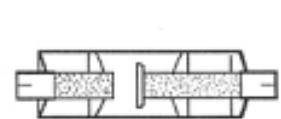

Style J

- These diagrams represent many of the common external & internal configurations possible for mufflers
- Muffler configurations can be designed to suit individual specifications.

MUFFLERS—HEAVY DUTY**REACTIVE**

PART NO	INLET ID	BODY SIZE	BODY LENGTH	STYLE Ext/Int
M1044-400R	102mm (4")	254 x	1130mm	AC
M1044-500R	127mm (5")	254 x	1130mm	AC
M1044-5C	127mm (5")	254 x	1130mm	AD
M1044-5D	127mm (5")	254 x	1130mm	AD

MUFFLERS—UNIVERSAL REACTIVE

PART NO	INLET ID	BODY SIZE	BODY LENGTH	STYLE Ext/Int
M830-300R	76mm (3")	203 x	762mm	AC
M830-300R-1	76mm (3")	203 x	762mm	AJ
M832-300R	76mm (3")	203 x	817mm	AC
M836-500R	127mm (5")	203 x	914mm	AC
M838-250R	63mm (2½")	203 x	965mm	AC
M838-300R	76mm (3")	203 x	965mm	AC
M838-350R	89mm (3½")	203 x	965mm	AC
M934-400R	102mm (4")	229 x	864mm	AC
M936-400R	102mm (4")	229 x	914mm	AC
M936-500A	127mm (5")	229 x	914mm	AC
M936-500R	127mm (5")	229 x	914mm	AC
M940-400R	102mm (4")	229 x	1016mm	AC
M944-350R	89mm (3½")	229 x	1130mm	AC
M944-400R	102mm (4")	229 x	1130mm	AC
M944-500R	127mm (5")	229 x	1130mm	AC

MUFFLERS— MID RANGE

PART NO	INLET ID	BODY SIZE	BODY LENGTH	STYLE Ext/Int
M540-250A	63mm (2½")	127 x	1016mm	-
M624-200A	51mm (2")	152 x	610mm	AB
M624-225A	57mm (2¼")	152 x	610mm	AB
M624-250A	693mm (2½")	152 x	610mm	AB
M624-300A	76mm (3")	152 x	610mm	AB
M624-350A	89mm (3½")	152 x	610mm	AB
M630-225A	57mm (2¼")	152 x	760mm	AB
M630-250A	63mm (2½")	152 x	760mm	AB
M630-300A	76mm (3")	152 x	760mm	AB
M630-350A	89mm (3½")	152 x	760mm	AB
M636-300A	76mm (3")	152 x	914mm	AB
M724-225A	57mm (2¼")	178 x	610mm	AB
M724-250A	63mm (2½")	178 x	610mm	AB
M724-300A	76mm (3")	178 x	610mm	AB
M724-350A	89mm (3½")	178 x	610mm	AB
M730-250A	63mm (2½")	178 x	762mm	AB
M730-300A	76mm (3")	178 x	760mm	AB
M730-350A	89mm (3½")	178 x	760mm	AB

RESONATOR—TYPE 1

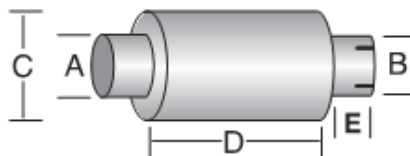

PART NO	INLET ID A	OUTLET ID B	BODY SIZE C	BODY LENGTH D	INLET LENGTH E
86556M	76mm	76mm	229mm	292mm	64mm
86150M	89mm	89mm	229mm	292mm	25mm
86144M	102mm	102mm	229mm	292mm	64mm
86145M	127mm	127mm	229mm	292mm	64mm

MUFFLERS TYPE 1

End In/Opposite End Out—Both on Centre

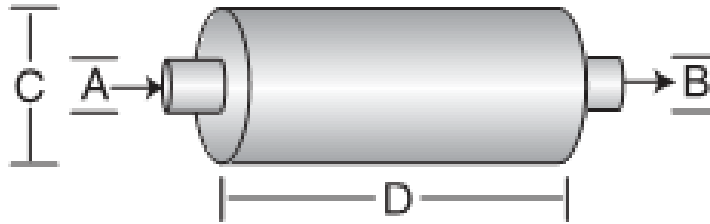

PART NO	INLET ID A	OUTLET ID B	BODY SIZE C	BODY LENGTH D	MAX FLOW		NOTES
					3" Hg	2" Hg	
09167T	41mm (1 ³ / ₅ "	41mm (1 ³ / ₅ "	109mm	447mm	**		ID/ID
86177M	51mm (2"	51mm (2"	107mm	323mm	400	340	ID/OD
86178M	64mm (2 ¹ / ₂ "	66mm (2 ³ / ₅ "	117mm	399mm	560	470	ID/OD
86186m	64mm (2 ¹ / ₂ "	64mm (2 ¹ / ₂ "	150mm	533mm	860	715	ID/ID
20153T	76mm (3"	79mm (3 ¹ / ₉ "	206mm	310mm	**		ID/OD
17257T	76mm (3"	76mm (3"	150mm	810mm	**		ID/ID
86187M	76mm (3"	76mm (3"	155mm	533mm	1100	920	ID/ID
01409T	76mm (3"	76mm (3"	220mm	320mm	**		ID/OD

End In/Opposite End Out—Both on Centre

PART NO	INLET ID A	OUTLET ID B	BODY SIZE C	BODY LENGTH D	NOTES
MUF101	32mm (1¼")	32mm (1¼")	102mm	356mm	BAFFLED
MUF101A	44mm (1¾")	44mm (1¾")	102mm	305mm	BAFFLED
MUF102	51mm (2")	51mm (2")	153mm	610mm	BAFFLED
MUF103	51mm (2")	51mm (2")	153mm	610mm	STRAIGHT
MUF104	57mm (2¼")	57mm (2¼")	153mm	610mm	BAFFLED
MUF105	57mm (2¼")	57mm (2¼")	153mm	610mm	STRAIGHT
MUF106	57mm (2¼")	57mm (2¼")	178mm	610mm	BAFFLED
MUF107	57mm (2¼")	57mm (2¼")	178mm	610mm	STRAIGHT
MUF108	63mm (2½")	63mm (2½")	153mm	610mm	BAFFLED
MUF109	63mm (2½")	63mm (2½")	153mm	610mm	STRAIGHT
MUF110	63mm (2½")	63mm (2½")	153mm	610mm	STRAIGHT-DOMED
MUF111	63mm (2½")	63mm (2½")	178mm	610mm	BAFFLED
MUF112	63mm (2½")	63mm (2½")	178mm	610mm	STRAIGHT
MUF113	63mm (2½")	63mm (2½")	204mm	610mm	BAFFLED
MUF114	63mm (2½")	63mm (2½")	204mm	610mm	STRAIGHT
MUF115	63mm (2½")	63mm (2½")	204mm	762mm	BAFFLED
MUF116	70mm (2¾")	70mm (2¾")	204mm	610mm	BAFFLED
MUF117	76mm (3")	76mm (3")	153mm	610mm	BAFFLED
MUF118	76mm (3")	76mm (3")	153mm	610mm	STRAIGHT
MUF119	76mm (3")	76mm (3")	178mm	610mm	BAFFLED
MUF120	76mm (3")	76mm (3")	178mm	610mm	STRAIGHT
MUF121	76mm (3")	76mm (3")	178mm	610mm	STRAIGHT-DOMED
MUF122	76mm (3")	76mm (3")	178mm	762mm	BAFFLED
MUF123	76mm (3")	76mm (3")	203mm	610mm	BAFFLED
MUF125	76mm (3")	76mm (3")	203mm	610mm	STRAIGHT
MUF126	76mm (3")	76mm (3")	203mm	914mm	BAFFLED
MUF127	76mm (3")	76mm (3")	254mm	610mm	BAFFLED
MUF128	76mm (3")	76mm (3")	223mm	560mm	BAFFLED
MUF129	89mm (3.5")	89mm (3.5")	204mm	914mm	BAFFLED
MUF130	102mm (4")	102mm (4")	203mm	610mm	BAFFLED-DOMED
MUF133	127mm (5")	127mm (5")	178mm	500mm	STRAIGHT - SS
MUF134	44mm (1¾")	44mm (1¾")	203 x 102	390mm	OFFSET/OFFSET
MUF135	51mm (2")	51mm (2")	203 x 102	355mm	OFFSET/OFFSET

End In/Opposite End Out—Both on Centre

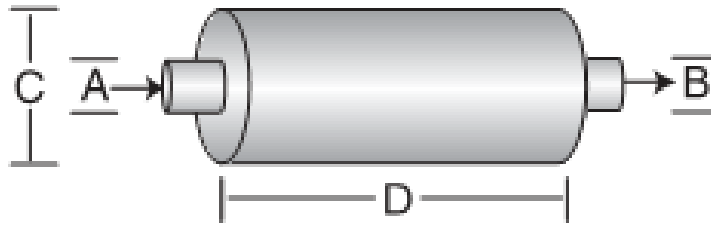

PART NO	INLET ID A	OUTLET ID B	BODY SIZE C	BODY LENGTH D	MAX FLOW		NOTES
					3" Hg	2" Hg	
86690M	81mm (3 ¹ / ₆ "	81mm (3 ¹ / ₆ "	257mm	580mm	1000	815	ID/ID
86188M	89mm (3 ¹ / ₂ "	89mm (3 ¹ / ₂ "	180mm	762mm	1450	1200	ID/ID
86113M	89mm (3 ¹ / ₂ "	89mm (3 ¹ / ₂ "	229mm	1130mm	1200	1000	ID/ID
86216M	89mm (3 ¹ / ₂ "	89mm (3 ¹ / ₂ "	229mm	1130mm	1200	1000	ID/ID Dbl Wrapped
86189M	102mm (4")	102mm (4")	180mm	711mm	2100	1750	ID/ID
86127M	102mm (4")	102mm (4")	216mm	874mm	2000	1670	ID/ID
86131M	102mm (4")	102mm (4")	229mm	1130mm	2000	1670	ID/ID
86108M	102mm (4")	102mm (4")	229mm	1130mm	1600	1350	ID/ID
86630M	102mm (4")	102mm (4")	229mm	1130mm	1600	1350	HD 86108M
86740M (Economy)	102mm (4")	127mm (5")	229mm	1130mm	1900	1500	ID/ID
86111M	102mm (4")	102mm (4")	229mm	1130mm	1230	1025	ID/ID
86560M	102mm (4")	102mm (4")	229mm	508mm	2000	1670	ID/ID
86561M	102mm (4")	102mm (4")	229mm	711mm	1875	1580	ID/ID
86544M	102mm (4")	102mm (4")	257mm	1130mm	1600	1350	ID/ID
86215M	102mm (4")	102mm (4")	257mm	1130mm	1400	1150	ID/ID Dbl Wrapped
86713M (Economy)	102mm (4")	102mm (4")	229mm	1130mm	1750	1450	ID/OD
20619T	102mm (4")	105mm (4 ¹ / ₄ "	176mm	482mm	1540	1230	ID/OD
20620T	112mm (4 ² / ₅ "	114mm (4 ¹ / ₂ "	229mm	452mm	**		ID/ID

PART NO	DESCRIPTION
UNITRAC	UNIVERSAL TRACTOR MUFFLER
UNITRACAM	UNIVERSAL TRACTOR MUFFLER

MUFFLER TYPE 1

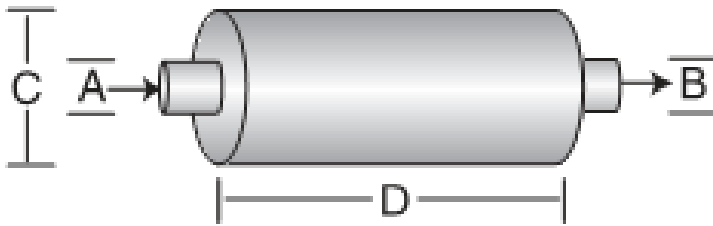

**End In/Opposite End Out
Both on Centre**

PART NO	INLET ID A	OUTLET ID B	BODY SIZE C	BODY LENGTH D	MAX FLOW 3" Hg 2" Hg	NOTES
M090594	102mm (4")	102mm (4")	229mm	508mm		ID/ID
M090595	127mm (5")	127mm (5")	229mm	673mm	2478 2023	ID/ID
86102M	127mm (5")	127mm (5")	229mm	1130mm	2160 1800	ID/ID
86132M	127mm (5")	127mm (5")	229mm	1130mm	3600 3000	ID/ID
86624M	127mm (5")	127mm (5")	229mm	851mm	2160 1800	ID/ID
86130M	127mm (5")	127mm (5")	229mm	1130mm	2300 1920	ID/ID
M101181	127mm (5")	127mm (5")	254mm	1295mm	2625 2305	ID/ID
86195M	127mm (5")	127mm (5")	257mm	1130mm	2800 2300	ID/ID
86531	127mm (5")	127mm (5")	257mm	1130mm	2800 2330	ID/ID
86739M (Economy)	127mm (5")	127mm (5")	257mm	1130mm	2850 2400	ID/ID
86656M	127mm (5")	127mm (5")	257mm	1130mm	3400 2775	ID/ID
86682M (Economy)	127mm (5")	127mm (5")	257mm	1130mm	2850 2400	ID/ID
86626M	127mm (5")	127mm (5")	257mm	1524mm	3000 2550	ID/ID
86786M (Single)	127mm (5")	127mm (5")	257mm	1130mm	— —	ID/ID
86791M (Dual)	127mm (5")	127mm (5")	257mm	1130mm	— —	ID/ID
86610M	152mm (6")	152mm (6")	282mm	1130mm	3700 3020	
20680T	64mm (2½")	64mm (2½")	(117 x 213mm) x	457mm	**	ID/OD
17704T	94mm (3⅝")	89mm (3½")	(155 x 257mm) x	635mm	**	ID/OD
20154T	112mm (4⅔")	114mm (4½")	(155 x 257mm) x	445mm	**	ID/OD

MUFFLER TYPE2

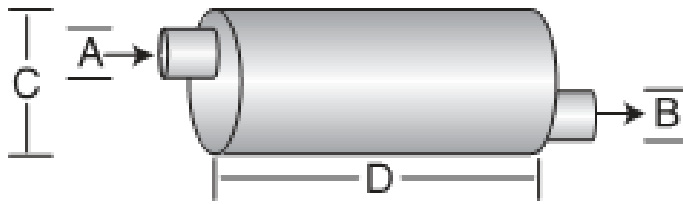

**End In/Opposite End Out
Both Offset**

ROUND

PART NO	INLET ID A	OUTLET ID B	BODY SIZE C	BODY LENGTH D	MAX FLOW		NOTES
					3" Hg	2" Hg	
86136M	51mm (2")	51mm (2")	155mm	610mm	500	420	ID/ID
86550M	57mm (2¼")	57mm (2¼")	155mm	655mm	410	330	ID/ID
86518M	64mm (2½")	66mm (2 ³ / ₅ ")	155mm	655mm	7700	640	ID/ID
86524m	64mm (2½")	64mm (2½")	155mm	737mm	800	670	ID/ID
86137M	64mm (2½")	64mm (2½")	168mm	711mm	800	670	ID/ID
86516M	64mm (2½")	70mm (2¾")	206mm	757mm	780	650	ID*2/OD
86517M	64mm (2½")	76mm (3")	206mm	960mm	900	750	ID*2/OD
86522M	64mm (2½")	70mm (2¾")	216mm	762mm	950	790	ID*2/OD
86525M	64mm (2½")	76mm (3")	216mm	792mm	780	650	ID*2/OD HD86184M
86667M	64mm (2½")	76mm (3")	216mm	965mm	850	710	Flange/Flange
86663M	69mm (2 ⁵ / ₇ ")	69mm (2 ⁵ / ₇ ")	69mm	180mm	750	630	ID/ID
86519M	70mm (2¾")	70mm (2¾")	180mm	856mm	770	640	ID/OD
86520M	70mm (2¾")	70mm (2¾")	180mm	856mm	770	640	ID/OD
86523M	70mm (2¾")	70mm (2¾")	180mm	889mm	800	670	ID/OD
M085207	76mm (3")	76mm (3")	216mm	559mm			ID/ID
86139M	76mm (3")	76mm (3")	216mm	792mm	1150	960	ID/ID Heavy Duty
86521M	76mm (3")	76mm (3")	216mm	792mm	1300	1000	ID/ID
86119M	76mm (3")	76mm (3")	216mm	706mm	1000	835	ID/ID
86134M	89mm (3½")	76mm (3")	216mm	965mm	1100	920	ID/ID
86500M	102mm (4")	102mm (4")	102mm	762mm	1700	1420	ID/ID Heavy Duty
86660M	102mm (4")	102mm (4")	102mm	914mm	1580	1320	ID/ID
86118M	102mm (4")	102mm (4")	257mm	914mm	1600	1350	ID/ID HD86118M
86662M	102mm (4")	102mm (4")	257mm	914mm	1600	1350	
86168M	102mm (4")	102mm (4")	267mm	851mm	1650	1375	

MUFFLERS— TYPE 2

End In/Opposite End Out—Both Offset

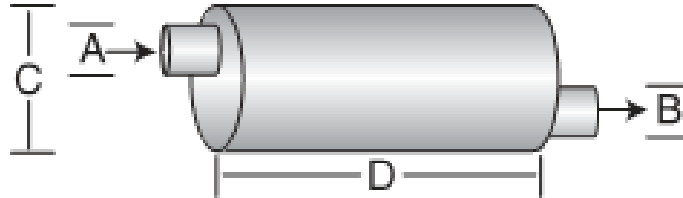

OVAL

PART NO	INLET ID A	OUTLET ID B	BODY SIZE C	BODY LENGTH D	MAX FLOW		NOTES
					3" Hg	2" Hg	
86666M	64mm (2½")	54mm (2⅛")	(104 x 229mm) x	483mm	320	260	ID/ID HD86635M
86675M	64mm (2½")	64mm (2½")	(104 x 229mm) x	711mm	625	510	ID/ID
86668M	70mm (2¾")	102mm (4")	(211 x 295mm) x	704mm	1300	1090	ID*2/OD
86159M	76mm (3")	76mm (3")	(211 x 292mm) x	660mm	1220	1020	ID/ID
86657M	76mm (3")	76mm (3")	(211 x 292mm) x	660mm	1000	775	ID/ID
86106M	89mm (3½")	89mm (3½")	(211 x 292mm) x	660mm	1050	880	ID/ID
86669M	89mm (3½")	102mm (4")	(211 x 292mm) x	711mm	1450	1210	ID/ID
86206M	89mm (3½")	89mm (3½")	(213 x 295mm) x	660mm	1500	1250	ID/ID Double Wrapped
22153T	102mm (4")	127mm (5")	(208 x 292mm) x	701mm	**		ID/OD
86179M	102mm (4")	102mm (4")	(211 x 292mm) x	686mm	1150	760	ID/ID
86661M	102mm (4")	102mm (4")	(211 x 292mm) x	686mm	1150	690	ID/ID HD86179M
86664M	102mm (4")	102mm (4")	(211 x 292mm) x	813mm	1150	1250	ID/ID Heavy Duty
86153M	102mm (4")	102mm (4")	(211 x 292mm) x	843mm	1650	1375	ID/ID
86125M	102mm (4")	102mm (4")	(254 x 381mm) x	660mm	1750	1460	ID/ID
86147m	127mm (5")	127mm (5")	(254 x 381mm) x	660MM	2950	2500	ID/ID
86117M	127mm (5")	127mm (5")	(254 x 381mm) x	914mm	2600	2170	ID/ID
86180M	152mm (6")	152mm (6")	(254 x 381mm) x	805mm	3800	3170	ID/ID

MUFFLERS TYPE 2A

End In/Opposite End Out—Both Offset



ROUND

PART NO	INLET ID A	INLET ID B	OUTLET ID C	BODY SIZE D	BODY LENGTH E	MAX FLOW 3" Hg 2" Hg	NOTES
86184M	64mm (2½")	64mm (2½")	76mm (3")	216mm	800mm	780 650	ID/ID

OVAL

PART NO	INLET ID A	INLET ID B	OUTLET ID	BODY SIZE	BODY LENGTH H	MAX FLOW 3" Hg 2" Hg	NOTES
86185M	70mm (2¾")	70mm (2¾")	102mm (4")	(211 x 292mm) x	703mm	1300 1090	ID/ID

MUFFLERS— TYPE 3

End In/End Out—Same End

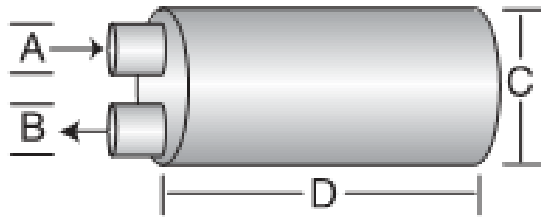

PART NO	INLET ID A	OUTLET ID B	BODY SIZE C	BODY LENGTH D
MUF301	51mm (2")	51mm (2")	153mm	429mm
MUF302	63mm (2½")	70mm (2¾")	216mm	559mm
MUF303	70mm (2¾")	70mm (2¾")	241mm	660mm
MUF304	77mm (3")	77mm (3")	203mm	609mm
MUF305	77mm (3")	77mm (3")	216mm	559mm
MUF306	81mm (3½")	81mm (3½")	292mm	711mm

ROUND

PART NO	INLET ID A	OUTLET ID B	BODY SIZE C	BODY LENGTH D	MAX FLOW 3" Hg 2" Hg	NOTES
86466M	102mm (4")	102mm (4")	257mm	711mm	1700 1420	ID/ID
86133M	102mm (4")	102mm (4")	257mm	711mm	1700 1420	ID/ID

OVAL

PART NO	INLET ID A	OUTLET ID B	BODY SIZE C	BODY LENGTH D	MAX FLOW 3" Hg 2" Hg	NOTES
12385T	77mm (3")	64mm (2½")	(152 x 356mm) x	457mm	845 690	ID/OD
86115M	102mm (4")	102mm (4")	(254 x 381mm) x	711mm	1600 1350	ID/ID
86116M	127mm (5")	127mm (5")	(254 x 381mm) x	900mm	2800 2300	ID/ID
86121M	128mm (5")	127mm (5")	(254 x 381mm) x	660mm	2200 1850	ID/ID

MUFFLERS— TYPE 4

End In/Opposite End Out—Outlet Offset

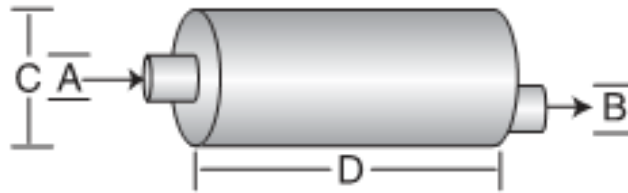

ROUND

PART NO	INLET ID A	OUTLET ID B	BODY SIZE C	BODY LENGTH D	MAX FLOW		NOTES
					3" Hg	2" Hg	
86200M	102mm (4")	102mm (4")	254mm	1130mm	1900	1590	ID/ID Dbl Wrapped

OVAL

PART NO	INLET ID A	OUTLET ID B	BODY SIZE C	BODY LENGTH D	MAX FLOW		NOTES
					3" Hg	2" Hg	
18202T	76mm (3")	84mm (3 ² / ₇ ")	(155 x 257mm) x	813mm	**		ID/OD
86203M	102mm (4")	102mm (4")	(257 x 384mm) x	914mm	1750	1460	ID/ID Dbl Wrapped

MUFFLERS— TYPE 5

Side In/End Out

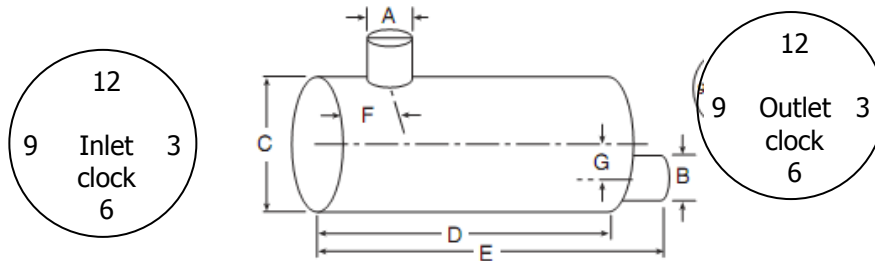

ROUND

PART NO	INLET ID A	OUTLET ID B	BODY SIZE C	BODY LENGTH D	OVERALL LENGTH E	INLET OFFSET F	OUTLET OFFSET G	INLET CLOCK POSI	OUT-LET CLOCK TION	MAX FLOW 3"Hg 2"Hg
86190M	51mm (2")	51mm (2")	155mm	477mm	546mm	89mm	35mm	6	3	350 300
86191M	64mm (2½")	64mm (2½")	168mm	528mm	597mm	89mm	35mm	6	3	640 535
86192M	76mm (3")	76mm (3")	216mm	686mm	749mm	114mm	50mm	6	3	1200 1000
05757T	80mm (3")	71mm (2¾/5")	142mm	495mm	571mm	84mm	-	6	0	**
86148M	102mm (4")	102mm (4")	257mm	711mm	775mm	61mm	185mm	6	1	1960 1600
86750M	127mm (5")	127mm (5")	257mm	1130mm	1225mm	140mm	-	6	0	2650 2160
86672M	127mm (5")	127mm (5")	282mm	914mm	996mm	724mm	68mm	12	6	1900 1590

OVAL

PART NO	INLET ID A	OUTLET ID B	BODY SIZE C	BODY LENGTH D	OVERALL LENGTH E	INLET OFFSET F	OUTLET OFFSET G	INLET CLOCK POSI	OUT-LET CLOCK TION	MAX FLOW 3"Hg 2"Hg
86193M	89mm (3½")	89mm (3½")	(210 x 292mm)	660mm	742mm	86mm	63mm	9	12	1100 920
86597M	102mm (4")	102mm (4")	(210 x 292mm)	700mm	785mm	411mm	63mm	1	3	1550 1290
86194M	127mm (5")	127mm (5")	(254 x 381mm)	914mm	1016mm	155mm	79mm	9	12	2200 1850

MUFFLERS— TYPE 7

End In / Side Out

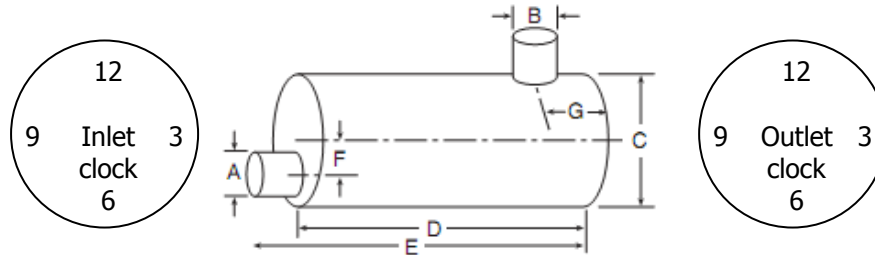

ROUND

PART NO	INLET ID A	OUTLET ID B	BODY SIZE C	BODY LENGTH D	OVERALL LENGTH E	INLET OFFSET F	OUTLET OFFSET G	INLET CLOCK POSI	OUTLET CLOCK TION	MAX FLOW 3"Hg 2"Hg
86152M	102mm (4")	102mm (4")	257mm	914mm	988mm	61mm	140mm	12	6	1570 1325
86501M	102mm (4")	102mm (4")	282mm	762mm	838mm	63mm	107mm	2	12	1950 1625
86530M	102mm (4")	102mm (4")	282mm	914mm	838mm	38mm	724mm	6	12	1720 1440
86151M	102mm (4")	102mm (4")	257mm	706mm	782mm	61mm	617mm	6	9:30	1600 1060

OVAL

PART NO	INLET ID A	OUTLET ID B	BODY SIZE C	BODY LENGTH D	OVERALL LENGTH E	INLET OFFSET F	OUTLET OFFSET G	INLET CLOCK POSI	OUTLET CLOCK TION	MAX FLOW 3"Hg 2"Hg
86220M	102mm (4")	102mm (4")	(254 x 381mm)	914mm						1270 1060

MUFFLER TYPE 8

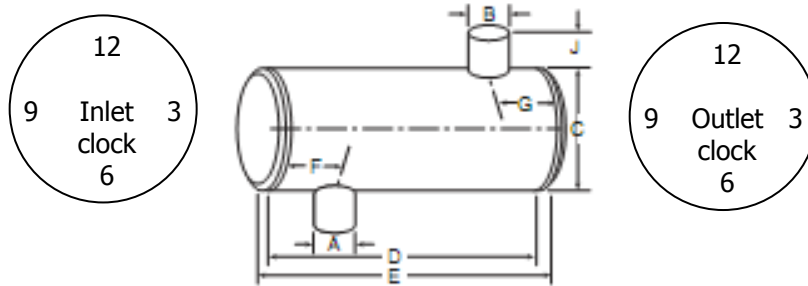

Side In / End Out

ROUND

PART NO	INLET ID A	OUTLET ID B	BODY SIZE C	BODY LENGTH D	OVERALL LENGTH E	INLET OFFSET F	OUTLET OFFSET G	INLET CLOCK POSI	OUTLET CLOCK TION	MAX FLOW 3" Hg 2" Hg
17410T	46mm (1 ⁴ / ₅ ")	46mm (1 ⁴ / ₅ ")	109mm	762mm	762mm	-	129mm	6	10:30	**

MUFFLER TYPE 10

**End In (female threads) / End Out (perforations)
Cup Muffler**

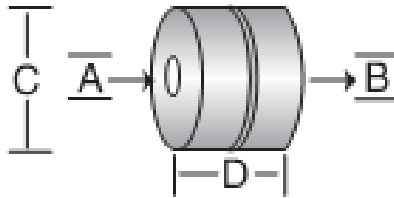

ROUND

PART NO	INLET ID A	OUTLET ID B	BODY SIZE C	BODY LENGTH D	MAX FLOW 3" Hg 2" Hg	NOTES
48111U	1" NPT	Perforations	107 x	83mm	**	
48113U	1 ¹ / ₄ " NPT	Perforations	108 x	83mm	**	

MUFFLERS - PERFORMANCE

DESCRIPTION	PART NO
4" in 5" out 9" body	7001379S
5" in 5" out 7" body S/S	7001383
5" in 5" out 7" body Straight through	DEX-MS-748-5
5" in 5" out 10" body	7001374S
5" in 6" out 7" body Straight through	DEX-MS-748-6
5" in 6" out 10" body	7001376S
5" in 7" out 7" body	DEX-MS-748-7
5" in 7" out 10" body	7001378S
6" in 6" out 10" body	7001377S



- Straight through design
- Fuel efficient
- Exhaust tone with grunt
- Inexpensive
- Extra Power
- Long lasting aluminized steel
- Easy to fit

MUFFLERS - SPORTS

DESCRIPTION
5" in 5" out 6" diameter body 44" long
5" in 6" out 6" diameter body 44" long

Nelson Sports Mufflers are manufactured at our Rocklea plant and are designed to provide maximum exhaust gas flow without restriction. Manufactured from aluminised steel with internal strength the Nelson Sports Muffler will provide years of satisfaction. Maximum power can be achieved with a distinctive exhaust tone. They come with a 150mm diameter body but with a choice of inlet and outlet sizes and installation clamping is available.

Please note these units do not conform to current ADR exhaust noise regulations & care must be exercised using engine compression brakes in residential areas.

UNIVERSAL SWIVEL HANGERS

PART NO	LENGTH	
89519K	244mm	9 ³ / ₅ "
90863K	337mm	13 ¹ / ₄ "
90843K	440mm	17 ¹ / ₄ "



- Several holes allow for quick installation of the required length.
- U-Bolt inserted through the closed square end and is attached to the exhaust component.
- Rubber isolator section allows for the bracket to 'swing' and absorb any vibration that may occur.

UNIVERSAL MUFFLER HANGERS—305mm Length

PART NO	BODY DIAMETER	
89534K	152mm	6"
89535K	178mm	7"
90004A	185mm	7 ² / ₇ "
89536K	203mm	8"
89538K	216mm	8 ¹ / ₂ "
89539K	229mm	9"
89540K	254mm	10"
900005A	279mm	11"
900006A	305mm	12"
89537K	210mm x 292mm	8 ¹ / ₂ " x 11 ¹ / ₂ "
89551K	254mm x 381mm	10" x 15"



- Heavy duty muffler body clamp and hanger strap.
- The strap can be shaped to fit the installation. Use for horizontal or vertical application.
- Use two for maximum rigidity.

UNIVERSAL MUFFLER HANGER BRACKET

PART NO	DESCRIPTION
UMH100	Universal Muffler Hanger Bracket
UMH101	Universal Muffler Hanger Bracket
UMH102	Universal Muffler Hanger Bracket

SPECIAL TILT CAB CONNECTORS

TUBE OD	TYPE	MILD STEEL
102mm	SET	0111TCS102
102mm	FEMALE	0111TCS102F
102mm	MALE	0111TCS102M
127mm	SET	0111TCS127
127mm	FEMALE	0111TCS127F
127mm	MALE	0111TCS127M

FEMALE



MALE



Special Tilt Cab Connectors are manufactured to closer tolerances to provide an extra positive gas tight seal.

TILT CAB CONNECTORS

TUBE OD	TYPE	MILD STEEL	ALUMINISED STEEL
102mm	SET	0111TCC102	0111TCC102A
102mm	FEMALE	0111TCC102F	0111TCC102FA
102mm	MALE	0111TCC102M	0111TCC102MA
127mm	SET	0111TCC127	0111TCC127A
127mm	FEMALE	0111TCC127F	0111TCC127FA
127mm	MALE	0111TCC127M	0111TCC127MA
152mm	SET	0111TCC152	0111TCC152A
152mm	FEMALE	0111TCC152F	0111TCC152FA
152mm	MALE	0111TCC152M	0111TCC152MA

FEMALE



MALE



Available in Mild & Aluminised Steel

STACK BRACKET

SIZE		DESCRIPTION	CHROME PLATED
152mm	6"	STACK BRACKET ZINC	BRK001
152mm	6"	STACK BRACKET CHROME	BRK002
178mm	7"	STACK BRACKET ZINC	BRK003
178mm	7" ID	STACK BRACKET ZINC	BRK004
178mm	7" ID	STACK BRACKET CHROME	BRK005

GUARD BRACKET

DESCRIPTION	ZINC PLATED
76mm GUARD CLAMP PIPE	BRK100
6" MUFF TO 10' GUARD KW	BRK102
7" MUFF TO 10' GUARD KW	BRK103
6" W/STAR J GUARD BRACKET	BRK104
7" W/STAR U GUARD BRACKET	BRK105
7" W/STAR J GUARD BRACKET	BRK106

AIR CLEANER MOUNTING BRACKET

SIZE	PART NUMBER
102mm 4"	BRK200
111mm 4.38"	BRK201
134mm 5.25"	BRK202
152mm 6"	BRK203
165mm 6.5"	BRK204
178mm 7"	BRK205
203mm 8"	BRK206
229mm 9"	BRK207
254mm 10.19"	BRK208
280mm 11"	BRK209
300mm 11.81"	BRK210
330mm 13"	BRK211
356mm 14"	BRK212
406mm 16"	BRK214

FULL GUARD BRACKET MOUNTING RINGS

SUIT GUARD DIAMETER	ZINC PLATED
152mm	FGMR06
203mm	FGMR08
229mm	FGMR09
254mm	FGMR10
280mm	FGMR11
305mm	FGMR12
356mm	FGMR14



HALF GUARD BRACKET MOUNTING RINGS

SUIT GUARD DIAMETER	ZINC PLATED
152mm	HGR06
203mm	HGR08
254mm	HGR10
305mm	HGR12



FULL GUARD WRAP—BRACKET KIT

TO FIT TUBE SIZE	CLAMPS PER KIT	PART NUMBER
127mm	2	90900K



- Can be modified for off-centre tubes
- Not visible above shield
- Includes 2 complete brackets and all hardware required to mount shield.

COTTON REEL MOUNT

PART NO	DESCRIPTION
BLT01	Cotton Reel Mount 2" x M10
BLT02	Cotton Reel Mount 1.5" x M8
BLT 03	Cotton Reel Mount 2.25" x M10
BLT04	Cotton Reel Mount 1" x M6
BLT05	UNIVERSAL RUBBER MOUNTS

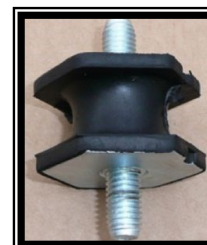

RUBBER MOUNT

PART NO	DESCRIPTION
BLT06	Mack Style Rubber Mount



METAL MOUNTING BRACKETS

A	B	C	D	E	F	MATERIAL	PART NO
4.4"	0.88"	4"	2.50"	.344"	0.50"	Mild Steel	3918218S
5.25"	0.88"	3.25"	3.12"	.344"	0.50"	Mild Steel	3918219S
6.5"	0.88"	3.75"	3.75"	.344"	0.50"	Mild Steel	3918220S
7.3"	0.88"	4.25"	4.15"	.344"	0.50"	Mild Steel	3918221S
7.89"	0.88"	4.25"	4.44"	.344"	0.50"	Mild Steel	3918222S
8.0"	1.25"	4.25"	4.88"	.406"	0.88"	Mild Steel	3918223S
8.5"	0.88"	4.25"	4.75"	.344"	0.50"	Mild Steel	3918224S
9.0"	1.25"	4.50"	5.38"	.406"	0.88"	Mild Steel	3918225S
10.2"	1.25"	5.00"	5.98"	.406"	0.88"	Mild Steel	3918226S
11.0"	1.25"	5.00"	6.38"	.406"	0.88"	Mild Steel	3918228S
12.1"	1.50"	8.00"	7.12"	.469"	1.06"	Mild Steel	3918231S
13.0"	1.50"	6.00"	7.56"	.469"	1.06"	Stainless	3918232S
14.0"	1.50"	8.00"	8.06"	.469"	1.06"	Mild Steel	3918234S



FULL GUARD BRACKETS

GUARD DIAMETER X PIPE DIAMETER	ZINC PLATED
152 x 51mm	0134GB152X51
57mm	0134GB152X57
63mm	0134GB152X63
76mm	0134GB152X76
89mm	0134GB152X89
203 x 63mm	0134GB203X63
76mm	0134GB203X76
89mm	0134GB203X89
102mm	0134GB203X102
127mm	0134GB203X127
229 x 127mm	0134GB229X127
254 x 63mm	0134GB254X63
76mm	0134GB254X76
89mm	0134GB254X89
102mm	0134GB254X102
127mm	0134GB254X127
280 x 76mm	0134GB280X76
89mm	0134GB280X89
102mm	0134GB280X102
127mm	0134GB280X127
305 x 76mm	0134GB305X76
89mm	0134GB305X89
102mm	0134GB305X102
127mm	0134GB305X127
152mm	0134GB305X152



- Zinc plated
- Nuts and bolts included

Two Brackets are required for each guard (top & bottom)

FULL EXHAUST GUARDS

GUARD DIAMETER X PIPE DIAMETER	STAINLESS STEEL
152 x 914mm	0134152F
1219mm	0134152FL
203 x 914mm	0134203F
1219mm	0134203FL
1500mm	-
254 x 1219mm	0134254F
280 x 1100mm	0134280F
1219mm	0134280FL
305 x 1219mm	0134305F



Brackets for full & half guards must be ordered separately to match pipe/exhaust size

HALF EXHAUST GUARDS

GUARD DIAMETER X PIPE DIAMETER	STAINLESS STEEL
152 x 914mm	0134152H
1219mm	0134152HL
203 x 914mm	0134203H
1219mm	0134203HL
1500mm	0134203HLX
254 x 1219mm	0134254H
280 x 1100mm	-
1219mm	-
305 x 1219mm	0134305H
330 x 1200mm	330 x 1200 (small)
470 x 1200mm	470 x 1200 (large)
1/2" guard 4"	HGS-04-48



Brackets for full & half guards must be ordered separately to match pipe/exhaust size

FULL GUARD WRAP—1219mm

MUFFLER DIAMETER	STYLE	STAINLESS STEEL	ALUMINISED STEEL
102—127mm	20mm Hole	89744C	89748A
152mm	20mm Hole	90856C	-
152mm	Vertical Slot	90976C	-
216—267mm	20mm Hole	89747C	-
216—267mm	Horizontal Slot	89996C	-
216—267mm	Vertical Slot	89745C	-

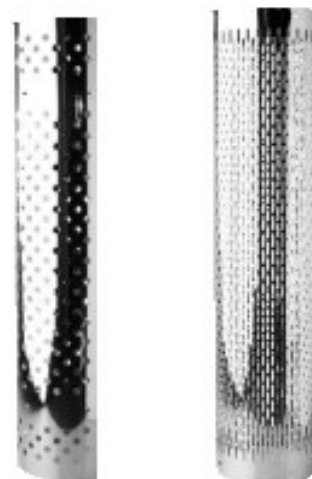

- polished bright Stainless Steel will not discolour, crack, chip or peel.
- Comes in a protective plastic wrap to prevent scratches whilst being shipped.
- 180°, 270°, 360° surface coverage available
 - 180° contains 2 sets of 2 mounting holes
 - 270° contains 2 sets of 4 mounting holes
 - 360° contains 2 sets of 4 mounting holes
- Guards do not have mounting rings included.

FULL GUARD WRAP—1245mm

MUFFLER DIAMETER	STYLE	STAINLESS STEEL	ALUMINISED STEEL
229—267mm	Vertical Slot	90901C	-
229—267mm	Blank Pattern	90948C	-

1/4 GUARD

DESCRIPTION	PART NO
S/S Guard 4" x 4ft	MG2348SS

3/4 GUARD WRAP

MUFFLER DIAMETER	STYLE	LENGTH	STAINLESS STEEL
216—257mm	20mm Hole	1219mm	89749C
216—257mm	Vertical Slot	1219mm	89774C
216—257mm	Horizontal Slot	1219mm	89995C
216—257mm	20mm Hole	1295mm	90555C
216—257mm	Horizontal Slot	1295mm	90556C
216—257mm	Blank Pattern	1295mm	90461C

CLAMP KITS

1/2 GUARD CLAMP KIT

CLAMP DIAMETER ID X OD	SUIT GUARD	CLAMPS PER KIT	STIANLESS STEEL	ALUMINIZED
102 x 146mm	1/2	2	89770K	-
127 x 171mm	1/2	2	89771K	-
152 x 197mm	1/2	2	90857K	-
216 x 267mm	1/2	2	89761K	-
229 x 273mm	1/2	2	89762K	-
257 x 301mm	1/2	2	89763K	-
178 x 208mm	1/2	1	-	BRK101
203 x 240mm	1/2	1	2690	-

3/4 GUARD CLAMP KIT

CLAMP DIAMETER	SUIT GUARD	CLAMPS PER KIT	STIANLESS STEEL
102 x 146mm	-	-	-
127 x 171mm	-	-	-
152 x 197mm	-	-	-
216 x 267mm	-	-	-
229 x 273mm	3/4	2	89766K
257 x 301mm	3/4	2	89767K
265 x 311mm	-	-	-



STAINLESS mounting hardware supplied with each kit

- 3 standoffs for 1/2 guard wrap
- 4 standoffs for 3/4 guard wrap

FULL GUARD CLAMP KIT

CLAMP DIAMETER	SUIT GUARD	CLAMPS PER KIT	STIANLESS STEEL
127mm	360	2	90900K

SPARK ARRESTORS—USA DESIGN

PART NO	ID	OD	BODY DIAMETER	BODY LENGTH	OVERALL LENGTH	INLET LENGTH	CFM RATING
49110U	27mm 1"	32mm 1¼"	108mm 4¼"	81mm 3⅓"	150mm 6"	33mm 1⅓"	80
49115U	38mm 1½"	38mm 1½"	108mm 4¼"	79mm 3⅓"	150mm 6"	36mm 1⅓"	165
49120B	51mm 2"	51mm 2"	143mm 5⅝"	163mm 6⅓"	279mm 11"	51mm 2"	295
49125A	64mm 2½"	67mm 2⅝"	143mm 5⅝"	218mm 8⅓"	325mm 12⅘"	51mm 2"	450
49130A	76mm 3"	80mm 3⅛"	168mm 6⅝"	259mm 10⅓"	378mm 15"	64mm 2½"	660
49135A	89mm 3½"	92mm 3⅝"	194mm 7⅝"	305mm 12"	447mm 17⅓"	76mm 3"	900
49140A	102mm 4"	105mm 4⅛"	216mm 8½"	371mm 14⅓"	538mm 21⅓"	86mm 3⅓"	1180
49150A	127mm 5"	130mm 5⅛"	244mm 9⅝"	406mm 16"	610mm 24"	102mm 4"	1840
49160A	152mm 6"	156mm 6⅛"	308mm 12⅝"	559mm 22"	686mm 27"	51mm 2"	2650

- Designed for universal application with a minimum of restriction on the engine. They work well as add-on units to existing exhaust systems. Their light weight and small size reduce stress and vibration to the rest of the exhaust system. Typical applications include logging and construction equipment, agricultural machinery, off road trucks, airport equipment, forestry and military vehicles.
- All arrestors exceed U.S. Forestry requirements, and are qualified and tested for vertical and horizontal installations under the U.S. Forestry Service Standard 5100-1b.
- All inlets are slotted tube connections. Outlets are OD tubing.
- CFM rating is based on a pressure drop of 1PSI.

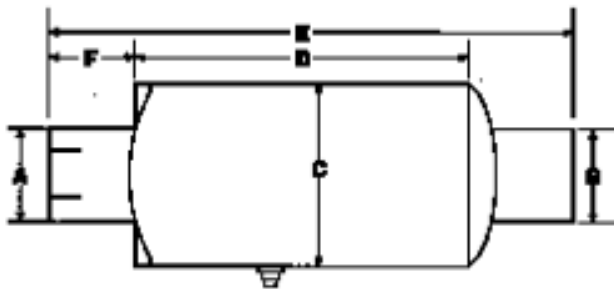

Inner Ø (A)	Outer Ø(B)	C	D	E	F	Flow m³/min.	Part-No.
1.05"/27mm	1.25"/32mm	108mm	81mm	150mm	33mm	2,3	49110U
1.50"/38mm	1.50"/38mm	108mm	79mm	150mm	36mm	4,7	49115U
2.00"/51mm	2.00"/51mm	143mm	163mm	279mm	51mm	8,4	49120B
2.50"/64mm	2.63"/67mm	143mm	218mm	325mm	51mm	12,7	49125A
3.00"/76mm	3.13"/80mm	168mm	259mm	378mm	64mm	18,7	49130A
3.50"/89mm	3.63"/92mm	194mm	305mm	447mm	76mm	25,5	49135A
4.00"/102mm	4.13"/105mm	216mm	371mm	538mm	86mm	33,4	49140A
5.00"/127mm	5.13"/130mm	244mm	406mm	610mm	102mm	52,1	49150A
6.00"/152mm	6.13"/156mm	308mm	559mm	686mm	51mm	75,0	49160A

SPARK ARRESTORS—Cyclonic Type

Scooped Baffle

PART NO	INLET ID	POWER RATING	MAX kw
SATA-51	51mm 2"	65HP	53kw
SATA-57	57mm 2¼"	65HP	53kw
SATA-63	63mm 2½"	65HP	53kw
SATA-76	76mm 3"	120HP	53kw

- These Spark Arrestors have a 'drain plug' that must be periodically opened with the engine running to clean out the unit and help maintain peak performance of the unit.
- Cyclonic Type Scooped Baffle Spark Arrestors are manufactured by Fleetguard Australia to conform to Australian Standard AS1019.



Scooped Baffle

SPARK ARRESTORS—Screen Type

Up to 53kw (70HP) 2" Outlet

PART NO	INLET ID	BODY DIAMETER	BODY LENGTH
SAA-4138	38mm (1½")	102mm x	220mm
SAA-4145	45mm (1¾")	102mm x	220mm
SAA-4151	51mm (2")	102mm x	220mm
SAA-4157	57mm (2¼")	102mm x	220mm
SAA-4163	63mm (2½")	102mm	220mm

Up to 104kw (140HP) 3" Outlet

PART NO	INLET ID	BODY DIAMETER	BODY LENGTH
SAA-5151	51mm (2")	127mm x	300mm
SAA-5157	57mm (2¼")	127mm x	300mm
SAA-5163	63mm (2½")	127mm x	300mm
SAA-5176	76mm (3")	27mm x	300mm

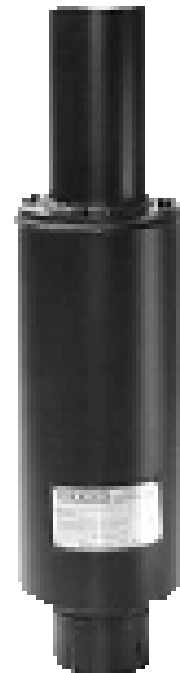

Spark Arrester

- These Spark Arrestors have a screen element that must be periodically removed (four bolts) and shaken clean to maintain peak performance of the unit. Spare Parts in the form of replacement outlet units are available.
- Screen Type Spark Arrestors and Spark Arrester Mufflers are manufactured by Fleetguard Australia to conform to Australian Standard AS1019.
- All the Spark Arrestors on this page can be mounted either horizontally or vertically.

SPARK ARRESTOR MUFFLERS—Screen Type

Up to 53kw (70HP)

PART NO	INLET ID	BODY DIAMETER	BODY LENGTH
SAMA-4138	38mm (1½")	102mm x	440mm
SAMA-4145	45mm (1¾")	102mm x	440mm
SAMA-4151	51mm (2")	102mm x	440mm
SAMA-4157	57mm (2¼")	102mm x	440mm
SAMA-4163	63mm (2½")	102mm x	440mm

Up to 104kw (140HP)

PART NO	INLET ID	BODY DIAMETER	BODY LENGTH
SAMA-5151	51mm (2")	127mm x	500mm
SAMA-5157	57mm (2¼")	127mm x	500mm
SAMA-5163	63mm (2½")	127mm x	500mm
SAMA-5176	76mm (3")	127mm x	500mm

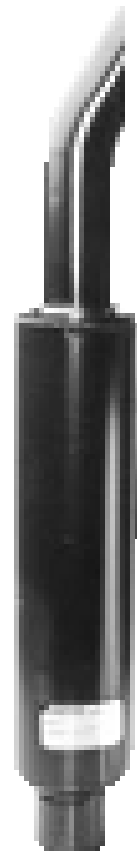

Spark Arrestor Muffler

- These Spark Arrestors have a screen element that must be periodically removed (four bolts) and shaken clean to maintain peak performance of the unit. Spare Parts in the form of replacement outlet units are available.
- Screen Type Spark Arrestors and Spark Arrestor Mufflers are manufactured by Fleetguard Australia to conform to Australian Standard AS1019.
- All the Spark Arrestors on this page can be mounted either horizontally or vertically.

PRE CLEANERS

DESCRIPTION	PART NO
3" Hi Flow Pre Cleaner	H000820
4" Hi Flow Pre Cleaner	H002045
4.5" Top Spin Pre Cleaner	H002427
2" Pre Cleaner	H002040
2¼" Pre Cleaner	H001250
2½" Pre Cleaner	H001251
3" Pre Cleaner	H001249
4" Pre Cleaner	H000858
4.5" Pre Cleaner	H000823
5" Pre Cleaner	H002043
6" Pre Cleaner	H002223
7" Pre Cleaner	H002224



PRE CLEANERS - SY-KLONE

Specifications

PART NO	CFM		M3/min		A		B		C	
	Min	Max	Min	Max						
AP8407	10	50	.03	1.5	2"	50.8mm	4.5"	114.3mm	3"	76.2mm
AP8408	50	120	2.1	5.7	3"	76.2mm	6.7"	170.18mm	4.2"	106.68mm
AP8403	100	350	2.8	11.3	4"	101.6mm	8.5"	215.9mm	6.28"	159.51mm
AP8409	350	450	9.9	15.5	4"	101.6mm	8.5"	215.9mm	6.28"	159.51mm
AP8404	400	650	11.3	25.5	6"	152.4mm	13.1"	332.74mm	11.1"	281.94mm
AP8410	650	800	17.0	31.1	6"	152.4mm	13.1"	332.74mm	11.1"	281.94mm
AP8405	800	1300	22.6	36.8	8"	203.2mm	18"	457.2mm	14.44"	366.776mm
AP8406	1300	1800	36.8	51.0	8"	203.2mm	18"	457.2mm	14.44"	366.776mm



PRE CLEANERS—ENGINEAIRE

Specifications

PART NO	SIZE ID		CFM Min Max		M3/min Min Max		A		B	
E200	2"	50mm	20 - 100		.56 - 2.8		3.125"	80mm	4.75"	120mm
E255	2.50"	63mm	100 - 200		2.8 - 5.6		4.250"	108mm	6.00"	152mm
E330	3"	76mm	140 - 350		4.0 - 9.8		4.75"	120mm	8.25"	210mm
E440S	4"	100mm	140 - 350		4.0 - 9.8		4.75"	120mm	8.25"	210mm
E445	4.50"	115mm	300 - 600		8.5 - 16.8		7.125"	180mm	10.625"	270mm
E550	5"	127mm	300 - 600		8.5 - 16.8		7.125"	180mm	10.625"	270mm
E660S	6"	152mm	300 - 600		8.5 - 16.8		7.125"	180mm	10.625"	270mm
E660	6"	152mm	400 - 850		11 - 23.8		7.125"	180mm	12.25"	311mm
E770L	7"	178mm	500 - 1400		14 - 39		7.25"	184mm	14.125"	358mm
E880	8"	200mm	500 - 1400		14 - 39		7.25"	184mm	14.125"	358mm
E990	9"	228mm	900 - 2000		25.7 - 56.5		8.125"	206mm	17.125"	435mm



REPLACEMENT BOWL

PART NO	DESCRIPTION
P016330	10.5" Replacement Bowl
P020227	7.25" Replacement Bowl
P020344	11.94" Replacement Bowl
P020648	7.34" Replacement Cover

AIR INTAKE—RUBBERWARE 90° ELBOWS

ID	OD	A	B	C	D	R	PART NO	STYLE
51mm 2"	60mm 2.38"	4.5"	5.5"	-	-	2"	3316564S	1
57mm (2¼")	95mm 3.74"	3.74"	-	-	-	2¼"	P105530	1
64mm 2.5"	73mm 2.88"	4.25"	4.25"	-	-	1.75"	3316565S	1
76mm 3"	89mm 3.5"	5.25"	5.25"	1.75"	1.5"	2"	3316566S	1
89mm 3.5"	102mm 4"	5.5"	5.5"	1.75"	1.5"	2"	3316567S	1
102mm 4"	114mm 4.5"	5.75"	5.75"	1.75"	1.5"	2"	3316568S	1
114mm 4.5"	127mm 5"	6"	6"	1.75"	1.5"	1.75"	3316569S	1
127mm 5"	140mm 5.5"	6.12"	6.12"	1.75"	1.62"	1.75"	3316570S	2
140mm 5.5"	152mm 6"	6.5"	6.5"	1.75"	1.75"	1.75"	3316571S	2
140mm 5.5"	152mm 6"	8"	5.5"	4.5"	1.5"	1"	89829K	2
152mm 6"	165mm 6.5"	7"	7"	2.25"	2"	1.75"	3316573S	2
152mm 6"	165mm 6.5"	5"	5"	1.5"	1.5"	1"	89830K	2
152mm 6"	165mm 6.5"	7"	9"	4.25"	2"	1.75"	89826K	2
178mm 7"	194mm 7.62"	7.56"	7.56"	2.25"	2"	1.75"	3316576S	2
203mm 8"	222mm 8.75"	8.5"	8.5"	2"	2.25"	2.12"	36316577S	2
254mm 10"	237mm 10.75"	10.5"	10.5"	2.25"	2.25"	3.12"	3316578S	2

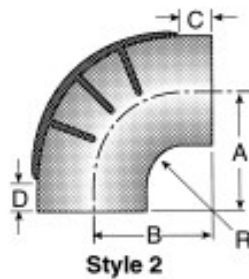
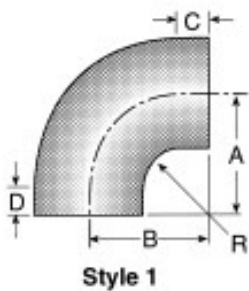

AIR INTAKE—RUBBERWARE 45° ELBOWS

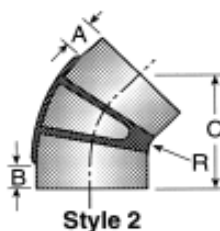
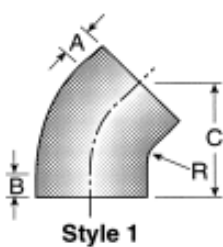

AIR INTAKE—RUBBERWARE 45° ELBOWS

ID	OD	A	B	C	R	PART NO	STYLE
57mm (2¼")	-	-	-	-	2¼"	P105542	1
76mm 3"	89mm 3.5"	1.5"	1.5"	5.5"	2"	3316579S	1
89mm 3.5"	102mm 4"	4.5"	4.5"	5.5"	2"	3316580S	1
102mm 4"	114mm 4.5"	1.5"	1.5"	5.5"	2"	3316581S	1
114mm 4.5"	127mm 5"	1.5"	1.5"	5.75"	1.75"	3316582S	1
127mm 5"	140mm 5.5"	1.62"	1.62"	5.25"	1.75"	3316583S	1
140mm 5.5"	152mm 6"	1.75"	1.75"	6.25"	1.75"	3316584S	1
152mm 6"	165mm 6.5"	2"	2"	6.5"	1.75"	3316585S	2
178mm 7"	194mm 7.62"	2.25"	2.25"	8"	1.75"	3316586S	2
203mm 8"	222mm 8.75"	2.25"	2.25"	8.25"	2.12"	3316587S	2
254mm 10"	237mm 10.75"	2.25"	2.25"	10.5"	3.12"	3316588S	2

AIR INTAKE—RUBBERWARE SPECIAL ELBOWS—MISCELLANEOUS ANGLES

DEGREE	ID	OD	A	B	C	R	PART NO	STYLE
22°	102mm 4"	114mm 4.5"	1.5"	1.5"	4.5"	1.75"	3316596S	1
68°	114mm 4.5"	127mm 5"	1.5"	1.5"	6.75"	1.75"	3316597S	1
22°	140mm 5.5"	152mm 6"	1.75"	1.75"	5.25"	1.75"	3316598S	1
54°	140mm 5.5"	152mm 6"	1.75"	1.75"	7.75"	2.5"	3316599S	1
68°	140mm 5.5"	152mm 6"	1.75"	1.75"	8.25"	4"	3316600S	1
22°	152mm 6"	165mm 6.5"	1.75"	1.75"	5.25"	1.75"	3316601S	1
38°	152mm 6"	165mm 6.5"	2.3"	2.3"	7.25"	0.72"	3316602S	1
54°	152mm 6"	165mm 6.5"	1.5"	1.5"	7.5"	2.5"	3316603S	2
68°	152mm 6"	165mm 6.5"	1.75"	1.75"	8.5"	4"	3316604S	2
63°	203mm 8"	222mm 8.75"	2"	2"	11"	1.25"	3316605S	2

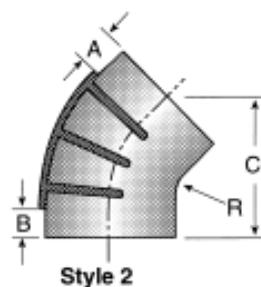
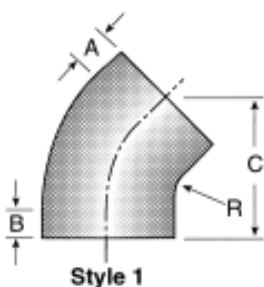

AIR INTAKE—RUBBERWARE REDUCING 90° ELBOWS

A (ID)	B (ID)	C	D	E	F	R	PART NO
127mm 5"	152mm 6"	7"	6"	1.5"	1.7"	1.5"	3316589S
140mm 5.5"	152mm 6"	6.75"	6.75"	1.75"	1.75"	1.75"	3316590S
127mm 5"	178mm 7"	6.75"	6.75"	1.75"	2.75"	1.5"	3316591S
152mm 6"	178mm 7"	9"	7.56"	6"	3"	0.5"	3316593S
127mm 5"	102mm 4"	-	-	-	-	-	89898K

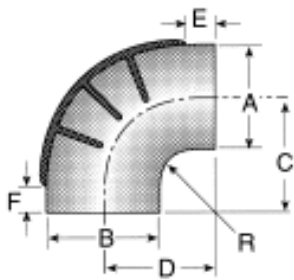

AIR INTAKE—RUBBERWARE REDUCING 45° ELBOWS

ID	ID	A	B	C	R	PART NO	STYL E
152mm x 140mm 6.00" x 5.50"	164mm 6.44"	1.75"	1.75"	6.5"	4.87"	3316594S	1
178mm x 152mm 7.00" x 6.00"	187mm 7.38"	2"	2"	7.38"	5.56"	3316595S	2

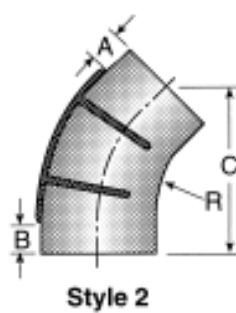
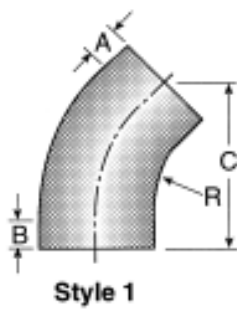

AIR INTAKE—RUBBERWARE HUMP HOSE

ID x ID	A	B	C	PART NO
76mm 3"	5.25"	4.5"	2"	3316606S
89mm 3.5"	5.25"	5"	2"	3316607S
102mm 4"	5.25"	5.37"	2"	3316608S
114mm 4.5"	5.25"	5.87"	1.75"	3316609S
127mm 5"	6"	6.12"	2.25"	3316610S
140mm 5.5"	6"	7"	2.25"	3316611S
152mm 6"	7"	7.5"	2.75"	3316612S
178mm 7"	7"	8.5"	2.5"	3316613S
203mm 8"	5"	9.5"	1.5"	3316614S
254mm 10"	6"	11.5"	2"	3316615S

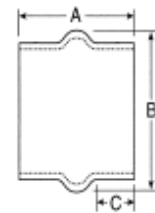

AIR INTAKE—RUBBERWARE HUMP HOSE REDUCERS

ID x ID	A	B	C	D	PART NO
76mm x 64mm 3" x 2.5"	6"	4.25"	2.12"	3"	900012K
89mm x 76mm 3.5" x 3"	5.25"	5"	2.12"	2.12"	3316616S
89mm x 102mm 3.5" x 4"	5"	5"	2"	2"	RHHR450
102mm x 76mm 4" x 4"	5.25"	5.5"	1.5"	1.75"	3316617S
127mm x 102mm 5" x 4"	5.5"	6.5"	1.5"	1.75"	3316618S
140mm x 102mm 5.5" x 4"	6"	7"	1.87"	2"	3316619S
140mm x 127mm 5.5" x 5"	6"	7"	1.87"	2"	3316620S
152mm x 127mm 6" x 5"	6"	7.5"	1.87"	2"	3316621S
152mm x 140mm 6" x 5.5"	6"	7.5"	2"	2"	3316622S
178mm x 127mm 7" x 5"	7"	8.5"	2.5"	2.5"	P136494
178mm x 140mm 7" x 5.5"	7"	8.5"	2.25"	2.75"	3316623S
178mm x 152mm 7" x 6"	5"	8.5"	1.44"	1.5"	3316624S
203mm x 152mm 8" x 6"	5"	9.5"	1.38"	1.5"	3316626S
203mm x 178mm 8" x 7"	5"	9.5"	1.44"	1.5"	3316627S
254mm x 203mm 10" x 8"	6"	11.5"	1.75"	2"	3316628S

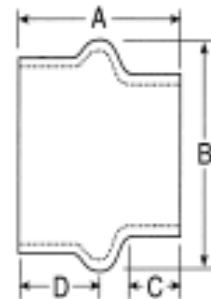

AIR INTAKE—RUBBERWARE REDUCING INSERT SLEEVE

A	B	C	D	E	PART NO
1.75	2.50	2.00	1.00	.25	3920175S
1.38	2.50	2.00	1.00	.25	3920138S
2.50	3.50	3.00	1.00	.25	3930250S
2.25	3.50	3.00	1.00	.25	3930225S
2.00	3.50	3.00	1.00	.25	3930200S
3.75	4.50	4.00	1.50	.25	3940375S
4.00	5.00	4.50	1.50	.25	3945400S
3.75	5.00	4.50	1.50	.25	3945375S
3.00	5.00	4.50	1.50	.25	3945300S
4.00	5.50	5.00	1.50	.25	3950400S
4.50	5.50	5.00	1.50	.25	3950450S
5.00	6.00	5.50	1.50	.25	3316631S
5.00	6.50	6.00	1.50	.50	3316632S
5.50	6.50	6.00	1.50	.25	3316633S

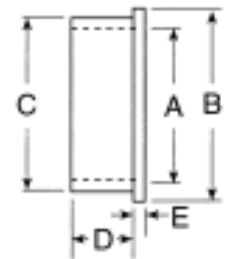

PART NO	DESCRIPTION
RBR100	178 OD>152 ID Rubber Insert
RBR101	204 OD>178 ID Rubber Insert

INTAKE CAP

PART NO	DESCRIPTION
H001725	7" Plastic Intake Cap Don
H001733	6" Plastic Intake Cap Don
H008149	3" Plastic Intake Cap Don
H008150	5" Plastic Intake Cap Don
H008154	4" Plastic Intake Cap Don
H001661	8" Air Ram Plastic

AIR INTAKE

INLET—STAINLESS STEEL

PART NO	DESCRIPTION
TR6000	6" T-RAM AIR INTAKES
TR7000	7" CHROME AIR RAMS



- No rust problems
- No clips or glue
- All seams welded
- Stylish woven mesh grille
- Manufactured in 304 stainless steel. High polish finish.

AIR RAM

PART NO	DESCRIPTION
X004995	LOW PROFILE AIR RAM 6" - 7"

FLANGES

SIZE		PART NO 2 BOLT	PART NO 3 BOLT
44mm	1¾"	FL044-2	-
51mm	2"	FLO51-2	FLO51
57mm	2.25"	FL057-2	FLO57
63mm	2.5"	FLO63-2	FLO63
76mm	3"	FLO76-2	FLO76
89mm	3.5"	FL089-2	FLO89

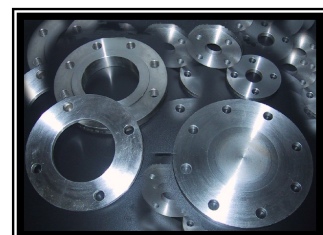

TABLE D FLANGES

SIZE		PART NO	PART NO BLIND	PART NO S/S PIPE FLANGE	PART NO S/S TUBE FLANGE
25mm	1"	TDF025	TDFB025	-	-
40mm	1.5"	TDF040	-	-	-
50mm	2"	TDF050	TDFB050	TDFSS050P	TDFSS050T
65mm	2.5"	TDF065	TDFB65	TDFSS065P	TDFSS065T
80mm	3"	TDF080	TDFB80	TDFSS080P	TDFSS080T
100mm	4"	TDF100	TDFB100	TDFSS100P	TDFSS100T
125mm	5"	TDF125	TDFB125	TDFSS125P	TDFSS125T
150mm	6"	TDF150	TDFB150	TDFSS150P	TDFSS150T
200mm	8"	TDF200	TDFB200	TDFSS200P	TDFSS200T
250mm	10"	TDF250	TDFB250	TDFSS250P	TDFSS250T
300mm	12"	TDF300	TDFB300	-	-
350mm	14"	TDF350	TDFB350	-	-
400mm	16"	TDF400	TDFB400	-	-

ASSORTED FLANGES

PART DESCRIPTION	PART NO
Machined Turbo Flange	89971K
Suit 3406 CAT	FLANGE - 4488
Flange Suit CAT 280 OD 8 hole	FLANGE 4564



FLANGE GASKETS

SIZE		PART NO - 2 BOLT	PART NO - 3 BOLT	PART NO
38mm	1.5"	FLG038-2	-	-
44mm	1.75"	FLG044-2	-	-
51mm	2"	FLG051-2	FLG051	
57mm	2.25"	FLG057-2	FLG057	-
63mm	2.5"	FLG063-2	FLG063	-
76mm	3"	FLG076-2	FLG076	-
89mm	3.5"	FLG089-2	FLG089	-
127mm	5"	FLG127	-	-
1.5mm	mat	-	-	GASKET

TABLE D GASKETS

SIZE		PART NO
25mm	1"	TDG025
40mm	1.5"	TDG040
50mm	2"	TDG050
65mm	2.5"	TDG065
80mm	3"	TDG080
100mm	4"	TDG100
125mm	5"	TDG125
150mm	6"	TDG150
200mm	8"	TDG200
250mm	10"	TDG250
300mm	12"	TDG300
350mm	14"	TDG350
400mm	15.75"	TDG400



JAPANESE INDUSTRIAL STANDARD

PART DISCIPTION		PART NO
JIS FLANGE 125	5"	JIS 125
JIS 150 FLANGE	6"	JIS 150

ASSORTED GASKETS

PART DESCRIPTION	PART NO
Caterpillar Gaskets 280x205mm	CAT GASKETS

- Nelson Exhaust carry a full range of Table D Flanges & Gaskets
- Additional style of flanges available on request.

NELSON EXHAUST RETURNS

Returns

Our policy on standard products that have to be returned is

- Prior notice must be received by the Sales Team before receipt of any goods;
- Goods must be accompanied by a copy of the original invoice;
- Goods must not be damaged or altered in any way and in original carton/box;
- All standard line items returned for credit after seven (7) days will be subject to a 10% re-stocking fee;
- Manufactured products & items cut to length cannot be returned;
- Freight costs will be the responsibility of the sender unless prior arrangements are made.

ADDITIONAL EXTRAS

Powder Coating & Chroming

Nelson Exhaust is also able to have your product powder coated or chromed to your requirements. Please speak with one of our informative sales team who will be able to advise you on what the requirements are, price and turn around time.

Brand names well known and distributed by Nelson Exhaust

Nelson Exhaust (Qld) Pty Ltd



CONTACT US



07 3274 2666

Fax 07 3275 2836



sales@nelsonexhaust.com.au

parts@nelsonexhaust.com.au

www.nelsonexhaust.com.au

Unit 5 / 1909 Ipswich Road
Rocklea Qld 4106



ABN 41 010 562 759

FAX

Muffler Order Request Form

Fax 07 3275 2836 or Email sales@nelsonexhaust.com.au

To Sales & Parts Department - Nelson Exhaust (Qld) Pty Ltd

From _____

Date ____ / ____ / 20____ No of pages ____

RE **MUFFLER ORDER REQUEST**

From
Contact Person _____

Company Name _____

Address

Tel _____ Fax _____

Email _____

Barrel Diameter _____ Length _____ Inlet Size _____ Plain/Exp Notch

Outer Style _____ Inner Style _____ Outlet Size _____ Plain/Exp Notch

Material Mild steel Aluminized Stainless Steel

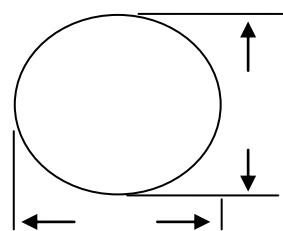
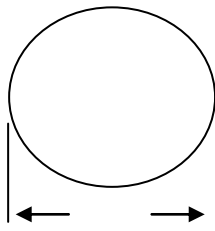
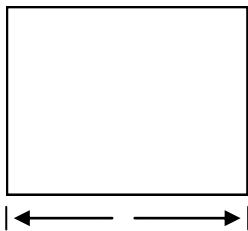

QUOTE

Date _____

Quote # _____

Price \$ _____

Quote valid to ____ / ____ / 20__

Valid for 30 days from date of quote